

TASCAM

CD-240

CD/NETWORK PLAYER

OWNER'S MANUAL

ENGLISH

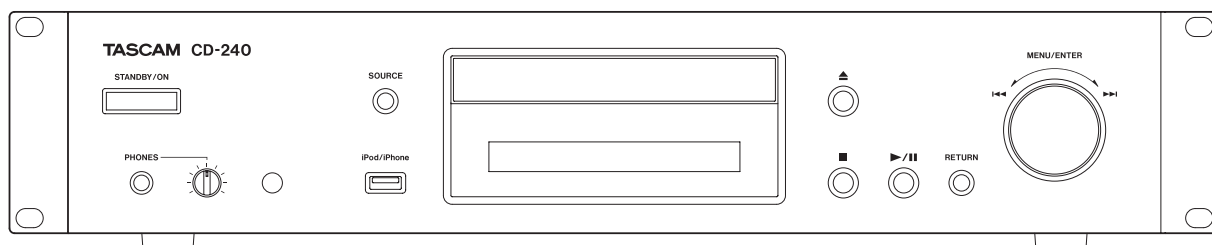

Trademarks and other legal statement

TASCAM is a trademark of TEAC Corporation, registered in the U.S. and other countries.

MPEG Layer-3 audio coding technology licensed from Fraunhofer IIS and Thomson.

“DSD” is a registered trademark.

This product is protected by certain intellectual property rights of Microsoft. Use or distribution of such technology outside of this product is prohibited without a license from Microsoft.

Microsoft, Windows, Windows Media and Internet Explorer are either registered trademarks or trademarks of Microsoft Corporation in the United States and/or other countries.

“Made for iPod” and “Made for iPhone” mean that an electronic accessory has been designed to connect specifically to iPod or iPhone, respectively, and has been certified by the developer to meet Apple performance standards.

Apple is not responsible for the operation of this device or its compliance with safety and regulatory standards.

Please note that the use of this accessory with iPod, or iPhone may affect wireless performance.

Apple, iPhone, iPod, iPod classic, iPod nano and iPod touch are trademarks of Apple Inc., registered in the U.S. and other countries.

App Store is a service mark of Apple Inc.

Android and Google Play are trademarks of Google Inc.

DLNA®, the DLNA Logo and DLNA CERTIFIED® are trademarks, service marks, or certification marks of the Digital Living Network Alliance.

Other company names and product names in this document are the trademarks or registered trademarks of their respective owners.

Information about copyrights and licensing related to open-source software is provided in the separate “Important Notice Regarding Software” document.

Notification about copyrights

This device is manufactured with professional applications in mind. Always sufficiently verify conditions related to each copyrighted material before using it with this unit in order to ensure appropriate use. Moreover, when using copyrighted music with this unit, permission must be obtained from the holder of each copyright. TEAC Corporation will bear no responsibility for rights infringements committed by users of this product.

IMPORTANT SAFETY INSTRUCTIONS



CAUTION
RISK OF ELECTRIC SHOCK
DO NOT OPEN



CAUTION: TO REDUCE THE RISK OF ELECTRIC SHOCK, DO NOT REMOVE COVER (OR BACK). NO USER-SERVICEABLE PARTS INSIDE. REFER SERVICING TO QUALIFIED SERVICE PERSONNEL.



The lightning flash with arrowhead in an equilateral triangle is intended to alert the user to the presence of uninsulated "dangerous voltage" within the product's enclosure that could be of sufficient magnitude to constitute a risk of electric shock to persons.



The exclamation point in an equilateral triangle is intended to alert the user to the presence of important operating and maintenance (servicing) instructions in the literature accompanying the appliance.

WARNING: TO PREVENT FIRE OR SHOCK HAZARD, DO NOT EXPOSE THIS APPLIANCE TO RAIN OR MOISTURE.

CAUTION

- DO NOT REMOVE EXTERNAL CASES OR CABINETS TO EXPOSE THE ELECTRONICS. NO USER SERVICEABLE PARTS ARE INSIDE.
- IF YOU ARE EXPERIENCING PROBLEMS WITH THIS PRODUCT, CONTACT THE STORE WHERE YOU PURCHASED THE UNIT FOR A SERVICE REFERRAL. DO NOT USE THE PRODUCT UNTIL IT HAS BEEN REPAIRED.
- USE OF CONTROLS OR ADJUSTMENTS OR PERFORMANCE OF PROCEDURES OTHER THAN THOSE SPECIFIED HEREIN COULD RESULT IN HAZARDOUS RADIATION EXPOSURE.

IN USA/CANADA, USE ONLY ON 120 V SUPPLY.

Model for USA

This device complies with part 15 of the FCC Rules. Operation is subject to the following two conditions: (1) This device may not cause harmful interference, and (2) this device must accept any interference received, including interference that may cause undesired operation.

CAUTION

Changes or modifications to this equipment not expressly approved by TEAC CORPORATION for compliance will void the user's warranty.

This equipment has been tested and found to comply with the limits for a Class B digital device, pursuant to Part 15 of the FCC Rules. These limits are designed to provide reasonable protection against harmful interference in a residential installation. This equipment generates, uses, and can radiate radio frequency energy and, if not installed and used in accordance with the instructions, may cause harmful interference to radio communications. However, there is no guarantee that interference will not occur in a particular installation. If this equipment does cause harmful interference to radio or television reception, which can be determined by turning the equipment off and on, the user is encouraged to try to correct the interference by one or more of the following measures:

- Reorient or relocate the equipment and/or the receiving antenna.
- Increase the separation between the equipment and receiver.
- Connect the equipment into an outlet on a circuit different from that to which the receiver is connected.
- Consult the dealer or an experienced radio/TV technician for help.

Model for Canada

Industry Canada's Compliance Statement:

THIS CLASS B DIGITAL APPARATUS COMPLIES WITH CANADIAN ICES-003.

CET APPAREIL NUMERIQUE DE LA CLASSE B EST CONFORME A LA NORME NMB-003 DU CANADA.

IMPORTANT SAFETY INSTRUCTIONS (continued)

- 1) Read these instructions.
- 2) Keep these instructions.
- 3) Heed all warnings.
- 4) Follow all instructions.
- 5) Do not use this apparatus near water.
- 6) Clean only with dry cloth.
- 7) Do not block any ventilation openings. Install in accordance with the manufacturer's instructions.
- 8) Do not install near any heat sources such as radiators, heat registers, stoves, or other apparatus (including amplifiers) that produce heat.
- 9) Do not defeat the safety purpose of the polarized or grounding-type plug. A polarized plug has two blades with one wider than the other. A grounding type plug has two blades and a third grounding prong. The wide blade or the third prong are provided for your safety. If the provided plug does not fit into your outlet, consult an electrician for replacement of the obsolete outlet.
- 10) Protect the power cord from being walked on or pinched particularly at plugs, convenience receptacles, and the point where they exit from the apparatus.
- 11) Only use attachments/accessories specified by the manufacturer.
- 12) Use only with the cart, stand, tripod, bracket, or table specified by the manufacturer, or sold with the apparatus. When a cart is used, use caution when moving the cart/apparatus combination to avoid injury from tip-over.
- 13) Unplug this apparatus during lightning storms or when unused for long periods of time.
- 14) Refer all servicing to qualified service personnel. Servicing is required when the apparatus has been damaged in any way, such as power-supply cord or plug is damaged, liquid has been spilled or objects have fallen into the apparatus, the apparatus has been exposed to rain or moisture, does not operate normally, or has been dropped.
 - The apparatus draws nominal non-operating power from the AC outlet with its POWER or STANDBY/ON switch not in the ON position.
 - The mains plug is used as the disconnect device, the disconnect device shall remain readily operable.
 - Caution should be taken when using earphones or headphones with the product because excessive sound pressure (volume) from earphones or headphones can cause hearing loss.



CAUTION

- Do not expose this apparatus to drips or splashes.
- Do not place any objects filled with liquids, such as vases, on the apparatus.
- Do not install this apparatus in a confined space such as a book case or similar unit.
- The apparatus should be located close enough to the AC outlet so that you can easily reach the power cord plug at any time.
- If the product uses batteries (including a battery pack or installed batteries), they should not be exposed to sunshine, fire or excessive heat.
- CAUTION for products that use replaceable lithium batteries: there is danger of explosion if a battery is replaced with an incorrect type of battery. Replace only with the same or equivalent type.

WARNING

Products with Class **I** construction are equipped with a power supply cord that has a grounding plug. The cord of such a product must be plugged into an AC outlet that has a protective grounding connection.

Precautions concerning batteries

Misuse of batteries could cause them to rupture or leak leading to fire, injury or the staining of nearby things. Please read and observe the following precautions carefully.

- Be sure to insert the batteries with correct positive (+) and negative (-) orientations.
- Use batteries of the same type. Never use different types of batteries together.
- If the remote control is not used for a long time (more than a month), remove the batteries to prevent them from leaking.
- If the batteries leak, wipe away the leakage inside the battery compartment and replace the batteries with new ones.
- Do not use batteries of types other than those specified. Do not mix new batteries with old ones or use different types of batteries together.
- Do not heat or disassemble batteries. Never throw batteries into fire or water.
- Do not carry or store batteries with other metallic objects. The batteries could short circuit, leak or explode.
- Never recharge a battery unless it is confirmed to be a rechargeable type.

DECLARATION OF CONFORMITY

We, TEAC EUROPE GmbH, Bahnstrasse 12, 65205 Wiesbaden-Erbenheim, Germany declare in own responsibility, the TEAC product described in this manual is in compliance with the corresponding technical standards.



This product contains a semiconductor laser system inside the cabinet and is classified as a "CLASS 1 LASER PRODUCT". To prevent being exposed to the laser beam, do not try to open the enclosure.

Laser:	
Type:	EP-C101
Manufacturer:	GUANGDONG EVER BRIGHT GROUP CO.,LTD.
Laser output:	Less than 0.3 mW
Wavelength:	790 ± 25 nm

Model for USA

This product has been designed and manufactured according to FDA regulations "title 21, CFR, chapter 1, subchapter J, based on the Radiation Control for Health and Safety Act of 1968", and is classified as class **I** laser product. There is not hazardous invisible laser radiation during operation because invisible laser radiation emitted inside of this product is completely confined in the protective housings.

The label required in this regulation is as follows:

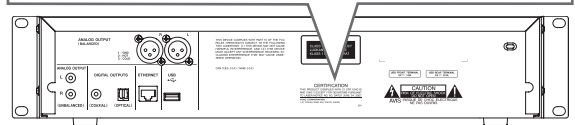

RACK-MOUNTING THE UNIT

Use the supplied rack-mounting kit to mount the unit in a standard 19-inch rack, as shown below. Remove the feet of the unit before mounting.

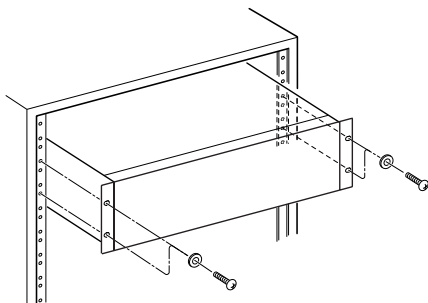

CAUTION

- Leave 1U of space above the unit for ventilation.
- Allow at least 10 cm (4 in) at the rear of the unit for ventilation.

For European Customers

Disposal of electrical and electronic equipment

- All electrical and electronic equipment should be disposed of separately from the municipal waste stream via collection facilities designated by the government or local authorities.
- By disposing of electrical and electronic equipment correctly, you will help save valuable resources and prevent any potential negative effects on human health and the environment.
- Improper disposal of waste electrical and electronic equipment can have serious effects on the environment and human health because of the presence of hazardous substances in the equipment.
- The Waste Electrical and Electronic Equipment (WEEE) symbol, which shows a wheeled bin that has been crossed out, indicates that electrical and electronic equipment must be collected and disposed of separately from household waste. 
- Return and collection systems are available to end users. For more detailed information about the disposal of old electrical and electronic equipment, please contact your city office, waste disposal service or the shop where you purchased the equipment.

Disposal of batteries and/or accumulators

- Waste batteries and/or accumulators should be disposed of separately from the municipal waste stream via collection facilities designated by the government or local authorities.
- By disposing of waste batteries and/or accumulators correctly, you will help save valuable resources and prevent any potential negative effects on human health and the environment.
- Improper disposal of waste batteries and/or accumulators can have serious effects on the environment and human health because of the presence of hazardous substances in them.
- The WEEE symbol, which shows a wheeled bin that has been crossed out, indicates that batteries and/or accumulators must be collected and disposed of separately from household waste.  **Pb, Hg, Cd**
If a battery or accumulator contains more than the specified values of lead (Pb), mercury (Hg), and/or cadmium (Cd) as defined in the Battery Directive (2006/66/EC), then the chemical symbols for those elements will be indicated beneath the WEEE symbol.
- Return and collection systems are available to end users. For more detailed information about the disposal of waste batteries and/or accumulators, please contact your city office, waste disposal service or the shop where you purchased them.

Contents

Thank you for choosing TASCAM.

Read this manual carefully to get the best performance from this unit.

After reading this manual, keep it in a safe place for future reference.

IMPORTANT SAFETY INSTRUCTIONS	3
Before use	7
Using an iPod or iPhone	8
Downloading the remote app	8
Notes about discs	9
USB and Networks	12
Connections	14
Names and functions of parts (main unit)	15
Names and functions of parts (remote control)	16
Using the remote control	17
Information shown on the display	18
Basic operation	19
Information shown on the display (CD/USB/NET)	22
Listening to CDs	24
Listening to files on a USB flash drive	30
Shuffle playback (CD/USB)	31
Repeat playback (CD/USB)	32
Listening to an iPod/iPhone	32
Using network services	33
My Favorites	34
DLNA	36
Home Media	38
Setting up Windows Media Player	39
Making shared folder settings	40
Settings	42

Inputting characters	45
Troubleshooting	46
Specifications	48

Before use

What's in the box

Check to be sure the box includes all the supplied accessories shown below. Please contact the store where you purchased this unit if any of these accessories are missing or have been damaged during transportation.

Main unit × 1

A rack-mounting screw kit × 1

Remote control (RC-1310) × 1

Batteries for remote control (AAA) × 2

Owner's manual (this document) × 1

Precautions for use

- Do not install this unit in a location that could become hot. This includes places that are exposed to direct sunlight or near a radiator, heater, stove or other heating equipment. Moreover, do not place it on top of an amplifier or other equipment that generates heat. Doing so could cause discoloration or deformation.
- Avoid locations that are extremely cold or exposed to excessive humidity or dust.
- In order to enable good heat dissipation, leave at least 20 cm (8") between this unit and walls and other equipment when installing it. If you put it in a rack, take precautions to prevent overheating by leaving at least 5 cm (2") open above the top of the unit and at least 10 cm (4") open behind the unit.
- Do not put cloth on top of the unit or place the unit on top of bedding or thick carpet. Doing so could cause the unit to overheat or damage it.
- Do not lift or move the unit during playback because the disc rotates at high speed. Doing so could damage the disc.
- Always remove any loaded disc before moving this unit or packing it for installation in a different location, for example. Moving the unit with a disc inside could cause a malfunction.
- This unit consumes power when in standby mode.
- Supply voltage to the unit that matches the voltage indicated on the rear panel. If you are in any doubt regarding this matter, consult an electrician.
- Do not open the body of the unit as this might result in damage to the circuitry or cause electric shock. If a foreign object should get into the unit, contact your dealer.
- When removing the power plug from an outlet, always pull directly on the plug. Never pull on the cord itself.

- If a TV is turned on while the unit is on, static might appear on the TV screen depending on the characteristics of the TV broadcast signal. This is not a malfunction of the unit nor of the TV. If this occurs, turn the unit off.

Product registration

Customers in the USA, please visit the TASCAM website (<http://tascam.com/>) to register as a user online.

Using the TEAC Global Site

You can download updates for this unit from the TEAC Global Site:

<http://teac-global.com/>

- 1) Open the TEAC Global Site.
- 2) In the TASCAM Downloads section, click the desired language to open the Downloads website page for that language.

NOTE

If the desired language does not appear, click Other Languages.

- 3) Click the "Search by Model Name" section to open the Downloads page for that product.
- 4) Select and download any updates that are needed.

Maintenance

Wipe dirt from the top cover and other panel surfaces using a soft cloth that has been slightly dampened with a diluted neutral cleanser.

Do not use chemically-treated wipes, thinner or similar substances because they could damage the surface of the unit.

- ⚠ **For safety, disconnect the power cord from the socket before cleaning.**

Using an iPod or iPhone

This unit can be connected to and used with the following iPod/iPhone models.

iPhone 5s, iPhone 5c, iPhone 5

iPhone 4s, iPhone 4

iPhone 3GS, iPhone 3G

iPhone

iPod touch (1st, 2nd, 3rd, 4th, and 5th generation)

iPod classic

iPod nano (2nd, 3rd, 4th, 5th, 6th, and 7th generation)

- This unit cannot output video from an iPod or iPhone.
- Use the USB cable supplied with the iPod or iPhone to connect it to the unit.

iPod/iPhone software

If the unit or remote control buttons do not work properly with your iPod or iPhone, updating its software might solve the problem.

Download the latest software for your iPod or iPhone from the following Apple website.

<http://www.apple.com/support/country/?dest=downloads>

Downloading the remote app

If you install the app on an iPod touch/iPhone or Android device, you can use it over a wireless network for basic control of the unit.

- You can download and use the app for free.



How to download the iPod touch/iPhone app

Search for "Teac Avr Remote" in the App Store.

How to download the Android app

Search for "Teac Avr Remote" on the Google play website (<https://play.google.com/store>).

Notes about discs

Types of discs that can be played by this unit

CDs with the "COMPACT disc DIGITAL AUDIO" logo



CD-R and CD-RW discs that have been properly recorded and finalized using the audio CD format.
CD-R and CD-RW discs that have been recorded with MP3/WAV files and properly finalized.

This unit can play the above types of discs without using an adapter. This unit cannot play discs of types other than those above.

⚠ CAUTION

If you try to play any other type of disc with this unit, loud noises that damage speakers or harm hearing could occur. Never try to play any type of disc other than those shown above.

- This unit might not be able to properly play Copy Control CDs, Dual Discs or other special CDs that do not conform to the Red Book CD standard. Operation and sound quality cannot be guaranteed when special discs are used in this unit. If playback of a special disc should cause trouble, contact the seller of the disc.

CD-R/CD-RW discs

This unit can play discs that are in audio CD format (CD-DA) and CD-R/CD-RW that have files in MP3 and WAV formats.

- Be sure to finalize discs created by CD recorders.
- Depending on the quality of the disc and the condition of the recording, playback might not be possible. For details, see the operation manual for the device you are using.
- If you have any questions about how to handle a CD-R or CD-RW disc, contact the seller of the disc directly.

Precautions for use

- Do not use cracked discs because they could damage the unit.
- When writing something on the label side of a disc, use a felt tip permanent marker. The use of a ballpoint pen or other pen with a hard tip could damage the disc, making it unplayable.
- Never use commercially-available CD stabilizers. Doing so could make the disc unplayable or damage the unit.
- Never use discs with irregular shapes, including heart-shaped and octagonal discs, because they could damage the unit.

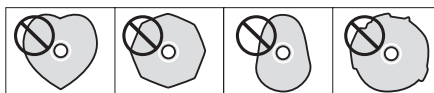

- If a CD-R/CD-RW disc that has a printable label surface is left in this unit for a long time, it could stick to the inside and become extremely difficult to remove and possibly even cause the unit to malfunction. Always remove such discs and store them in cases when not in use. Moreover, avoid using discs that have just been printed because they are especially prone to sticking.

Notes about discs (continued)

Handling discs

- Always load discs with their labeled sides up.
- Be careful when handling discs. If the side that contains the data (unlabeled side) is scratched, smudged with fingerprints or otherwise dirty or marred, errors could occur during playback.
- To remove a disc from its case, while pressing down on the center of the case, hold the disc by its edges.

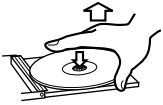

Removing discs



Holding discs



Disc storage

- After you finish using a disc, always put it back into its case for storage. Failure to do so could result in warping and scratches.
- Do not leave discs in places that are exposed to direct sunlight or that are very humid or hot. Doing so could cause discs to become deformed or degraded, making them unplayable.
- CD-R and CD-RW discs are more susceptible to the impacts of heat and ultraviolet rays than ordinary CDs. For this reason, do not leave them for long times in places that are exposed to direct sunlight or near devices that generate heat, for example.
- Always clean discs before storing them. Leaving a disc in an unclean state might result in skipping or degraded sound quality.

Maintenance

- If the side of the disc that has the data encoded on it (unlabeled side) becomes dirty with fingerprints or dust, use a soft cloth to wipe the surface from the center directly toward the edge.



- Never use record cleaners, antistatic treatments, thinners or similar chemicals to clean discs. Such chemicals could harm the surface of the disc.

MP3/WAV formats

This unit can play MP3 and WAV files that have been recorded on a CD-R or CD-RW disc.

- Playable audio file formats

MP3 (extension: ".mp3", ".MP3")

Standard	MPEG-1/MPEG-2 Audio Layer-2/Layer-3
Sampling Frequency	16 kHz, 22.05 kHz, 24 kHz, 32 kHz, 44.1 kHz, 48 kHz
Bit rate	8 kbps–320 kbps or VBR

- Variable bit rate (VBR) is supported. However, the time and other information shown on the display during playback of a VBR file might be incorrect sometimes.

WAV (extension: ".wav", ".WAV")

Sampling Frequency	8 kHz, 11.025 kHz, 12 kHz, 16 kHz, 22.05 kHz, 24 kHz, 32 kHz, 44.1 kHz, 48 kHz
Quantization bit rate	8-bit, 16-bit

Precautions when creating MP3/WAV discs using a computer

- This unit cannot play back discs that were not written in conformity to the ISO 9660 standard.
- The unit recognizes MP3 and WAV files by their file extensions, which are ".mp3" and ".wav", respectively. Always include the extension in the file name.
- The unit cannot recognize files without these file extensions. Even if one of these file extensions is added to a file name, however, this unit cannot play files that are not in the MP3 or WAV data format.
- After recording a CD-R/CD-RW disc, close the session (complete disc creation). This unit cannot play back discs that have unclosed sessions.
- This unit can play back files from a maximum of 99 folders. Furthermore, the unit can recognize and play back a maximum of 499 folders (including the root folder) and files.
- Multiple sessions recorded on the same disc are not supported. Only the first session on such discs can be played back.
- Depending on the condition of the disc, this unit might not be able to play it back or audio skipping could occur.
- This unit cannot play audio files with copyright protection from a disc.

USB and Networks

Audio files playable by this unit

This unit can play the following types of audio files over a USB or network connection.

MP3

File extension	.mp3, .MP3
Standard	MPEG-1/MPEG-2 Audio Layer-3
Sampling frequency	8 kHz, 11.025 kHz, 12kHz, 16 kHz, 22.05 kHz, 24 kHz, 32 kHz, 44.1 kHz, 48 kHz
Bit rate	8 kbps–320 kbps or VBR

WMA

File extension	.wma, .WMA
Sampling frequency	8 kHz, 11.025 kHz, 16 kHz, 22.05 kHz, 32 kHz, 44.1 kHz, 48 kHz
Bit rate	5 kbps–320 kbps or VBR

- This unit might not be able to play audio files with copyright protection from a USB or network source.
- WMA Pro/Voice not supported

WMA Lossless

File extension	.wma or .WMA
Sampling frequency	44.1 kHz, 48 kHz, 88.2 kHz, 96 kHz
Quantization bit rate	16-bit, 24-bit

WAV

File extension	.wav, .WAV
Sampling frequency	8 kHz, 11.025 kHz, 12 kHz, 16 kHz, 22.05 kHz, 24 kHz, 32 kHz, 44.1 kHz, 48 kHz, 64 kHz, 88.2 kHz, 96 kHz, 176.4 kHz, 192 kHz
Quantization bit rate	8-bit, 16-bit, 24-bit

- WAV files include uncompressed PCM digital audio.

AAC

File extension	.aac, .m4a, .mp4, .3gp, .3g2, .AAC, .M4A, .MP4, .3GP, .3G2
Standard	MPEG-2/MPEG-4 Audio
Sampling frequency	8 kHz, 11.025 kHz, 12 kHz, 16 kHz, 22.05 kHz, 24 kHz, 32 kHz, 44.1 kHz, 48 kHz, 64 kHz, 88.2 kHz, 96 kHz
Bit rate	8 kbps–320 kbps or VBR

FLAC

File extension	.flac, .FLAC
Sampling frequency	8 kHz, 11.025 kHz, 16 kHz, 22.05 kHz, 32 kHz, 44.1 kHz, 48 kHz, 64 kHz, 88.2 kHz, 96 kHz, 176.4 kHz, 192 kHz
Quantization bit rate	8-bit, 16-bit, 24-bit

Ogg Vorbis

File extension	.ogg, .OGG
Sampling frequency	8 kHz, 11.025 kHz, 16 kHz, 22.05 kHz, 32 kHz, 44.1 kHz, 48 kHz
Bit rate	48 kbps–500 kbps or VBR

- Incompatible files cannot be played back

LPCM (Linear PCM)

Sampling frequency	44.1 kHz, 48 kHz
Quantization bit rate	16-bit

- Playback only supported over a network.

Apple Lossless

File extension	.m4a, .mp4, .M4A, .MP4
Sampling frequency	8 kHz, 11.025 kHz, 12 kHz, 16 kHz, 22.05 kHz, 24 kHz, 32 kHz, 44.1 kHz, 48 kHz, 64 kHz, 88.2 kHz, 96 kHz
Quantization bit rate	16-bit, 24-bit

DSD

File extension	.dsf, .DSF
Sampling frequency	2.8224 MHz, 5.6448 MHz

CAUTION

- This unit does not support the following formats when using the Play To feature of Windows Media Player. FLAC, Ogg Vorbis, DSD
- When playing back audio files over a network, the types of file formats that can be played back also depend on the software running on the network server. For example, when using Windows Media Player 11, not all audio files on the computer can be played back. Only audio files that have been added to the Windows Media Player 11 library can be played back.
- When playing back files that have been recorded at variable bit rate (VBR), the playback time might not be shown correctly.

Notes about USB flash drives

This unit can use USB flash drives.*

*The USB ports on this unit only support USB flash drives (also known as “thumb drives” and “jump drives”). They do not support standard USB hard drives.

- FAT16 and FAT32 formats are supported for USB flash drives.
- If a USB flash drive is divided into multiple partitions, this unit will recognize them as separate volumes.
- This unit supports up to 20,000 files and 16 folder levels within a single folder.
- This unit does not support USB hubs or devices with USB hub functions. Never connect such devices to this unit.
- Neither WAV files with sampling rates of 176.4 kHz and higher nor 5.6MHz DSD files can be played back from a USB flash drive that is connected to the USB(R) port on the back of the unit.

CAUTION

- If the connected media is not supported, “Not Connected” appears on this unit’s display.
- This unit cannot play back audio files if copyright protection is used.
- Do not connect computers to this unit’s USB ports. Audio from computers cannot be input through this unit’s USB ports.
- This unit might not be able to use media that is loaded into a USB card reader.
- Depending on the USB flash drive and its contents, reading data from it might take some time.
- Depending on the USB flash drive, the unit might not be able to read its data correctly or supply power properly.
- During the use of USB flash drives, please be aware that our company will take no responsibility should data be lost or changed, a USB flash drive become damaged or other harm occur.
- We recommend backing up data saved on a USB flash drive before using it with this unit.
- This unit does not support USB flash drives with security functions.

Note about DLNA

The Digital Living Network Alliance (DLNA) is a group that is advancing the standardization of reciprocal connections and the exchange of audio, image, video and other data among computers, game devices and digital household appliances over ordinary home networks (LAN). This unit complies with version 1.5 of the DLNA guidelines.

Note about servers

This unit supports the following versions of Windows Media Player.

- Windows Media Player 11
- Windows Media Player 12
- Servers that comply with DLNA

A network server must be connected to the same network as this unit.

This unit supports up to 20,000 files and 16 folder levels within a single folder.

CAUTION

Depending on the type of media server, this unit might not recognize it or be able to play audio files saved on it.

Note about network services

- The network services that can be used will differ according to the region.
- Network services and contents that you can use through this unit could become unusable without warning if the service provider stops service.

Connections

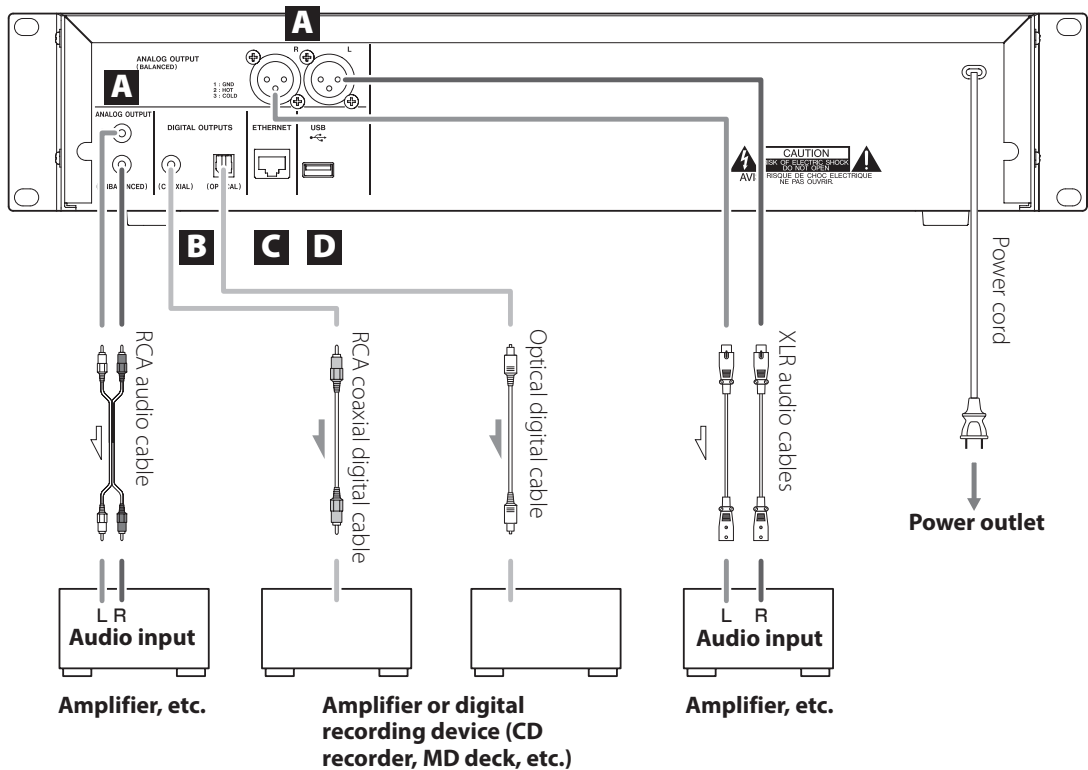

A Analog audio output (ANALOG OUTPUT) jacks

Use these to output two channels of analog audio. Connect the XLR jacks or RCA jacks to a stereo amplifier or powered speakers. Use commercially-available cables.

- XLR: Balanced XLR cables
- RCA: RCA audio cables

Connect the R jack of this unit to the right (R) jack of the amplifier and the L jack of this unit to the left (L) jack of the amplifier.

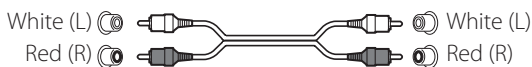

You can use the A.OUT ATT (analog output attenuation) menu item to reduce the signal level output from the analog audio output jacks (BALANCED and UNBALANCED) by 0 dB to -14 dB.

B Digital audio output (DIGITAL OUTPUTS) connectors

These output digital audio. Connect one of this unit's digital audio output connectors (COAXIAL or OPTICAL) to the digital audio input connector of an amplifier or

digital recording device such as a CD recorder. (They can be connected to different devices at the same time.)

- COAXIAL: Coaxial digital cable (RCA)
- OPTICAL: Optical digital cable (TOS)

C ETHERNET port

Use a commercially-available LAN cable to connect this port to a wired network or Internet connection.

- When changing the input source, this port is identified as "NET".

D USB port

Use to connect a USB flash drive to the unit.

- When changing the input source, this port is identified as "USB(R)".
- An iPod/iPhone cannot be connected here.
- Do not connect computers or similar devices to this unit's USB ports. Audio from computers cannot be input through this unit's USB ports.

Names and functions of parts (main unit)

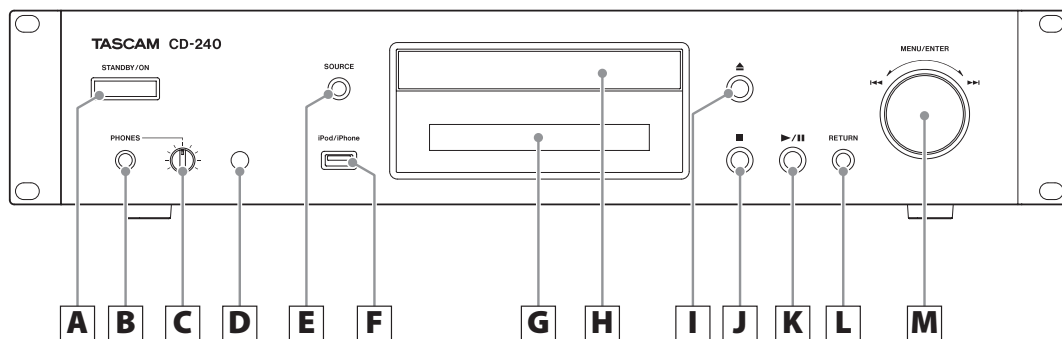

A STANDBY/ON button

Press this button to turn the unit on or put it in standby mode.

- When this unit is in standby mode, it consumes standby power. For this reason, we use the term “standby” rather than “off”.

B PHONES jack

To listen with headphones, minimize the volume before connecting them to the PHONES jack, and then gradually raise the volume.

- ⚠ Do not connect or disconnect headphones or turn the unit on or put it in standby while wearing them. Sudden loud noises could occur, which might cause hearing damage.**

C LEVEL knob

Use to adjust the headphones volume.
Turn it clockwise to increase and counterclockwise to decrease the volume.

D Remote control signal receiver

When using the remote control, point it toward this receiver.

E SOURCE button

Use this button to select the source.

F USB port

Use to connect an iPod, iPhone or USB flash drive to the unit.

- When changing the input source, this port is identified as “USB(F)”.

- Do not connect computers or similar devices to this unit’s USB ports. Audio from computers cannot be input through this unit’s USB ports.

G Display

H Disc tray

I Tray open/close (▲) button

Press to open and close the disc tray.

J Stop (■) button

Press to stop playback.

K Play/pause (▶/||) button

When stopped or paused, press to start playback.
During playback, press to pause.

L RETURN button

When a menu is open, press to return to the previous menu.

M MENU/ENTER (◀◀/▶▶) dial

Turn clockwise to skip to later tracks or counterclockwise to skip to earlier tracks.

Press to use as the ENTER button to confirm settings.
Press and hold to use as the MENU button.

Turn to change the item or setting value shown when a menu screen is open.

Names and functions of parts (remote control)

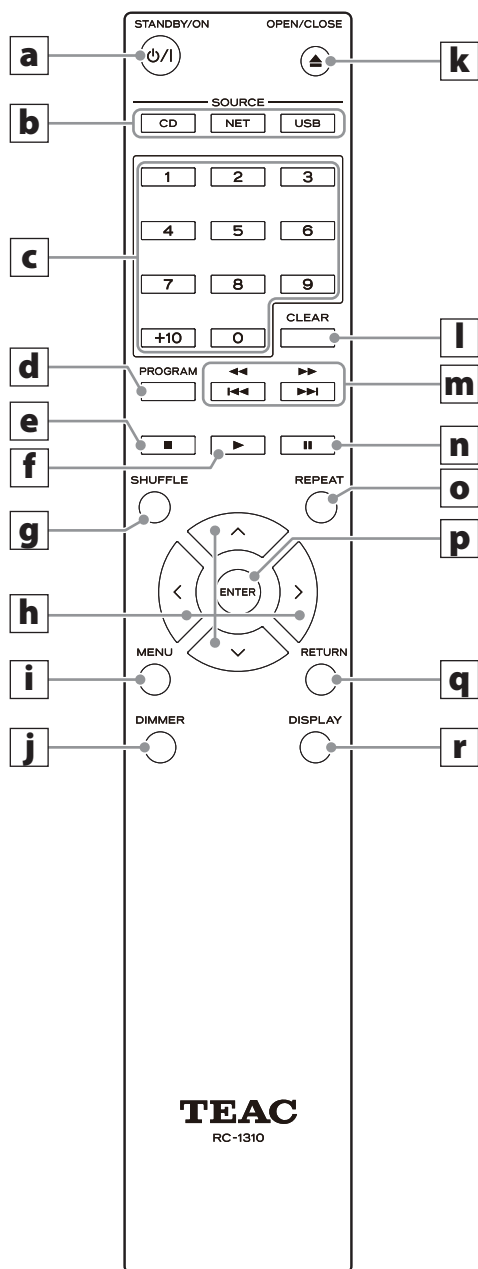

a STANDBY/ON (⏻/⏻) button

Press this button to turn the unit on or put it in standby mode.

b SOURCE buttons

Use these buttons to select the source.

- After selecting USB, press the USB button to switch between USB (F) and USB (R).

c Number buttons

Use these to input track, file and folder numbers.

d PROGRAM button

Use to set program playback.

e Stop (■) button

Press to stop playback.

f Playback (▶) button

Press to start playback when it is stopped or paused.

g SHUFFLE button

Use to change the shuffle playback setting.

h Direction (⏪/⏩/⏴/⏵) buttons

Use in menus and to change selected items.

i MENU button

Press to open the menu screen.

j DIMMER button

Use this button to change the brightness of the display.

k Tray open/close (⏮) button

Press to open and close the disc tray.

l CLEAR button

Use when setting program playback.

When both the main unit and the remote control have buttons with the same functions, the instructions in this manual refer only to one, but the other can be used in the same way.

Using the remote control

m Skip (|◀◀/▶▶|)/ Search (◀◀/▶▶) buttons

Use to skip to the previous or next track.
Use also when selecting folders and files.
Press and hold to search backward/forward.

n Pause (||) button

During playback, press to pause.
When paused, press to resume playback.

o REPEAT button

Use to change the repeat playback setting.

p ENTER button

Use to confirm menu selections and setting values.

q RETURN button

When a menu is open, press to return to the previous menu.

r DISPLAY button

Change the information shown.

Precautions for use

⚠ Misuse of batteries could cause them to rupture or leak leading to fire, injury or the staining of items nearby. Please carefully read and observe the precautions on page 4.

- When using the remote control, point it toward the remote control signal receiver on the main unit from a distance of 5 m (16 ft) or less.
- Do not place obstructions between the main unit and the remote control.
- The remote control might not work if the remote control signal receiver on the unit is exposed to direct sunlight or bright light. If this occurs, try moving the unit.
- Beware that use of this remote control could cause the unintentional operation of other devices that can be controlled by infrared rays.
- You can set the IR Remote menu item to Disable to make the unit stop responding to signals from remote controls.

Installing batteries

Remove the cover from the back of the remote control and insert two AAA batteries with their ⊕/⊖ ends oriented in the case as shown. Replace the cover.

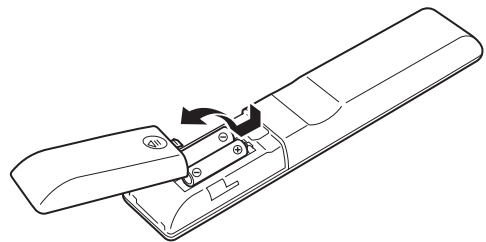

When to replace batteries

If the operation range of the remote control decreases, the batteries have become exhausted. In this case, replace the batteries with new ones. Dispose of the used batteries according to the instructions on them or requirements set by your local municipality.

Information shown on the display

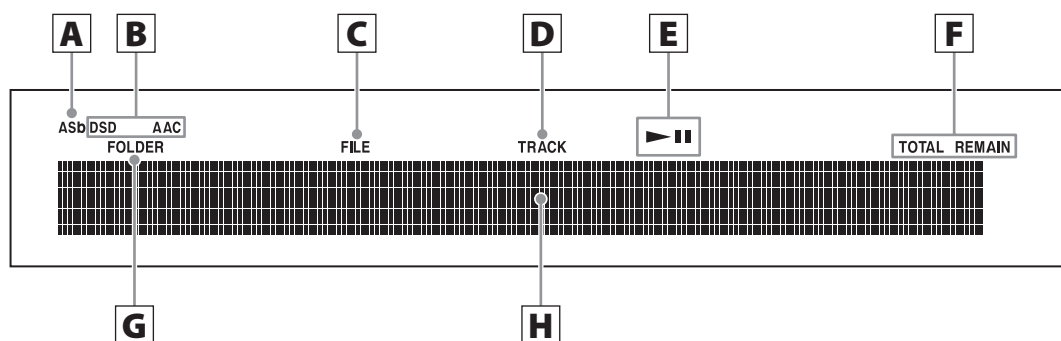

A Auto Standby (ASb) indicator

This indicator appears when the Auto Standby function is on.

B Format indicators

When the source is set to USB or NET, the DSD or AAC indicator appears according to the format of the audio file currently playing back.

C FILE indicator

When the source is set to CD and a disc containing audio files is loaded, this indicator appears. The file number is shown beneath the indicator.

D TRACK indicator

When the source is set to CD and an audio CD is loaded, this indicator appears. The track number is shown beneath the indicator.

E Play/pause (▶ / ||) indicator

F TOTAL REMAIN indicator

When the source is set to CD, this indicator shows what information about the disc is being displayed.

TOTAL: Total disc playback time

REMAIN: Remaining playback time of track being played

TOTAL REMAIN: Remaining playback time of disc being played

G FOLDER indicator

When the source is set to CD and a disc containing audio files is loaded, this indicator appears. The folder

number is shown beneath the indicator.

H Message display area

Track information and menus appear here.

The following icons appear in the message display area.

Icon	Explanation
	Folder*
	Track/Broadcast station name
	Playing back*
	Paused*
	Searching forward*
	Searching backward*
	Artist name
	Album name
	Repeat mode
	Repeat one track
	Folder repeat*
	Shuffle
	Shuffle repeat**
	Program**
	Program repeat**

*Does not appear when the source is CD.

**This only appears when the source is CD.

Basic operation

In this section, we explain operations that are the same in every mode.

- 1 Press the STANDBY/ON button to turn the unit on.**

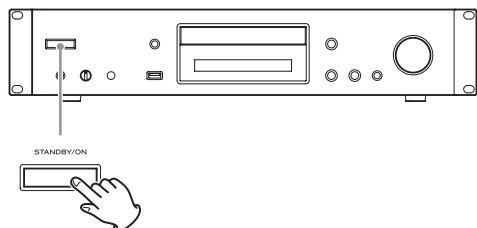

When input source set to CD

"CD" appears followed by the CD status on the display.

When input source not set to CD

The display shows the input source followed by "Now Initializing..." and then the source status.

- 2 Press the SOURCE button to change the source.**

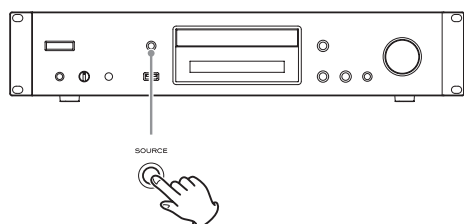

Each time you press the SOURCE button, the source changes as shown below.



When using the remote control to change the source, press the button for the source that you want to use (CD, NET or USB).

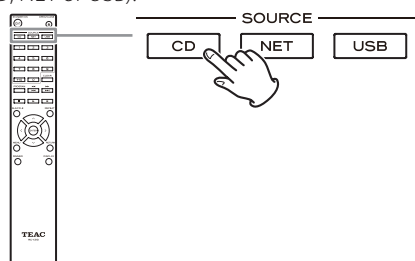

- 3 Start source playback.**

Auto Standby function

When the Auto Standby function is On, the unit will automatically enter standby mode if there is no audio input and this unit is not operated for 20 minutes. When the Auto Standby function is enabled, the ASb indicator appears on the display (page 44).

Press the STANDBY/ON button to exit standby mode.

Connecting headphones

Before using headphones, first minimize the volume. Then, plug the headphones (with a standard stereo plug) into the PHONES jack and gradually raise the volume using the LEVEL knob.

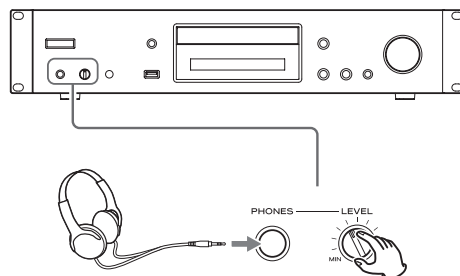

- ⚠ Always minimize the volume before plugging headphones in and putting them on. While wearing headphones, do not connect them to or disconnect them from the PHONES jack. Moreover, do not turn the unit on or put it in standby while wearing connected headphones. Doing so could result in a sudden loud noise that could harm your hearing.**

Basic operation (continued)

Starting playback

Press the play/pause (▶/||) button.

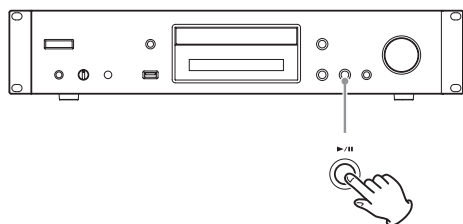

During playback, the ▶ icon appears at the top of the display.

Pausing playback

Press the play/pause (▶/||) button to pause playback. To resume playback from the position where it was paused, press the play/pause (▶/||) button again.

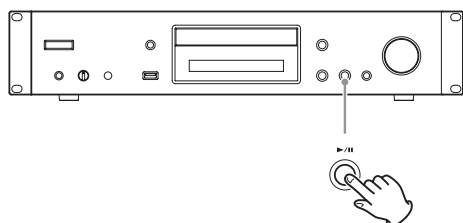

When paused, the || icon appears at the top of the display.

Stopping playback

Press the stop (■) button to stop playback.

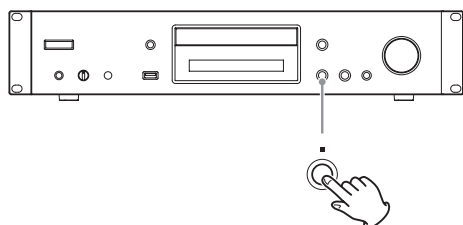

Skipping to search for a track

Turn the MENU/ENTER (◀◀/▶▶) dial to skip to tracks before or after the current track. Keep turning until the desired track is selected.

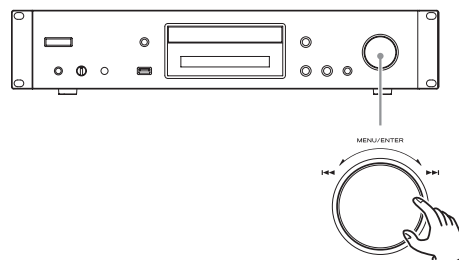

When using the remote control, use the skip (◀◀/▶▶) buttons. Use to skip to the previous or next track. Keep pressing until the desired track is selected.

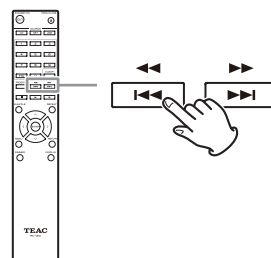

- During playback, press the ◀◀ button once to return to the beginning of the current track. To return to the beginning of the previous track, keep pressing the ◀◀ button.
- During program playback, tracks from earlier or later in the program will be played back.

Searching for part of a track

During playback, press a remote control search (◀◀/▶▶) button to search backward/forward. Release the button when you find the desired part. Playback resumes from that point.

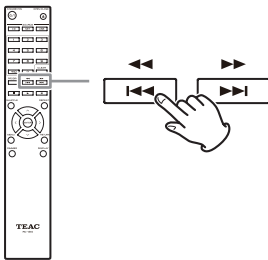

Dimmer

Press the remote control DIMMER button to cycle through display and indicator brightness levels.

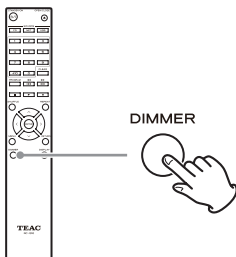

Playback order of audio files

Discs with audio files store them in folders in the same way that files are ordinarily managed on a computer. Moreover, some store multiple folders in one folder.

Example of folder numbers and file playback order (1-9) for a disc containing audio files during normal playback.

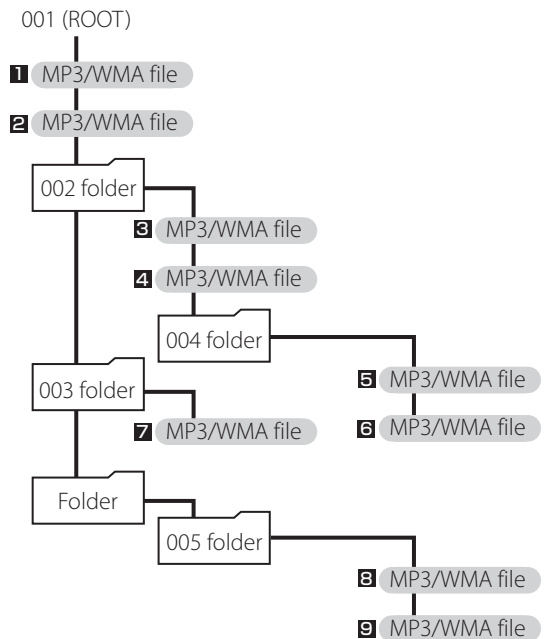

- The order in the illustration above might change if files or folders are added, deleted or moved.

Information shown on the display (CD/USB/NET)

Press the DISPLAY button during audio file playback to change the information shown on the display.

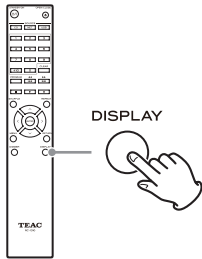

During audio CD playback

Information about the disc playing back is shown.

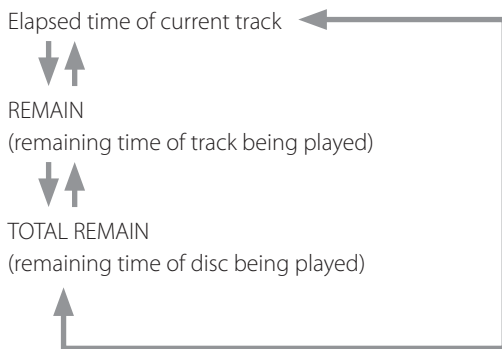

- If the shuffle playback or total playback time exceeds 99 minutes and 59 seconds, "– :– –" is shown.

During MP3/WAV disc playback

Various file information, including the title, artist and album ID3 tag information for the MP3/WAV file playing back is shown.

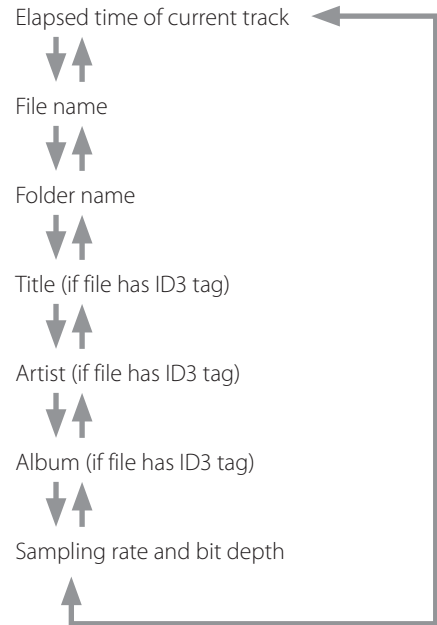

- If the file currently playing back exceeds 99 minutes and 59 seconds, "– :– –" is shown.
- Characters in track and folder names that cannot be shown are indicated with asterisks (*). The unit can also be set to show the file or folder number when characters that cannot be shown are included. See "BAD NAME" on page 43.
- WAV files do not have ID3 tags, so their titles and other information are not shown.

During USB/NET playback

Various file information, including the title, artist and album ID3 tag information for the audio file playing back is shown.

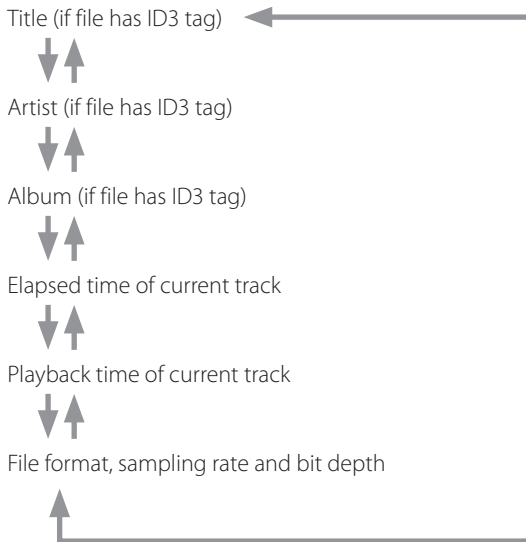

Listening to CDs

This unit can play the following types of discs and files.

Discs: CD-DA, CD-R, CD-RW

Files: MP3, WAV

1 Press the SOURCE button to change the source to CD.

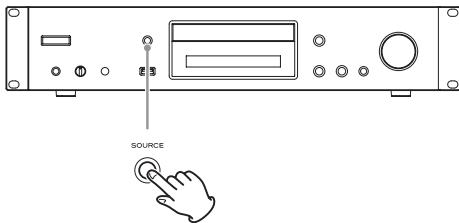

When using the remote control, press the CD button.

2 Press the tray open/close (▲) button.

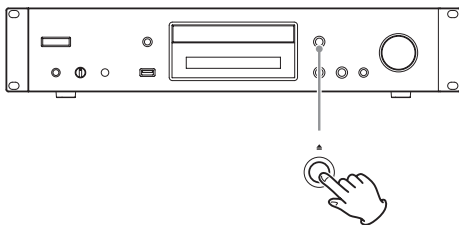

3 Place a disc on the tray with the labeled side up.

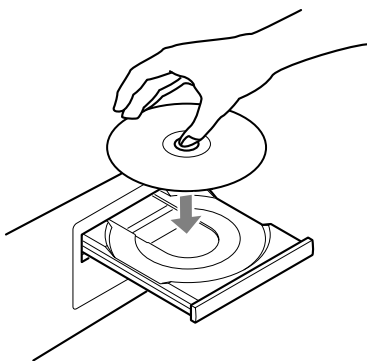

- Do not put more than one disc onto the tray at a time.
- If the tray is closed while a disc is outside the center guides, the disc might become stuck inside and the tray might not open. Be sure to always place discs within the guides at the center of the tray.
- When the tray is opening or closing, do not force it by hand.

4 Press the tray open/close (▲) button to close it.

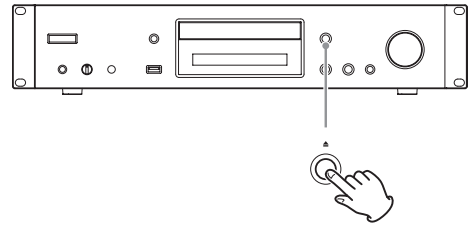

⚠ CAUTION

Be careful not to let your fingers be pinched when the tray closes.

"Reading" will appear on the display and the unit will start to read the disc.

- The unit takes some time to load the disc.
Wait until the total number of tracks and total playback time appear on the display.

When reading completes, the display will appear as follows.

Example: Audio CD loaded

This appears when the total playback time of the disc is shown.

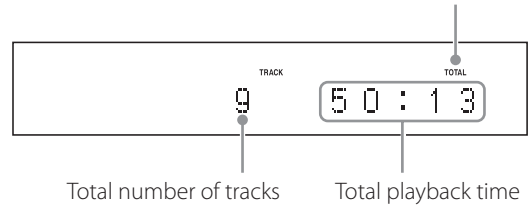

Example: MP3/WAV disc loaded

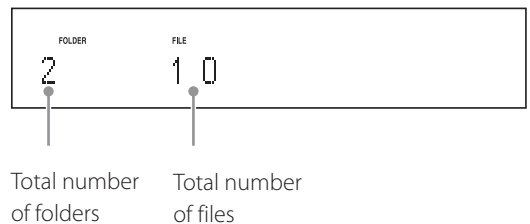

- "No Disc" appears if no disc has been loaded.

5 Press the play/pause (▶/||) button.

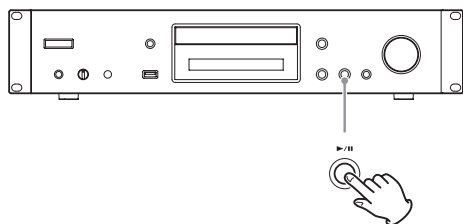

Playback starts from the first track.

Direct playback using track numbers

In addition to using the skip buttons to select tracks, you can input a track by number and start playback.

During playback or when stopped, you can use the remote control number buttons to select a track by number.

For a single-digit number, press the corresponding number button. For a double-digit number, press the +10 button followed by the number button for the tens digit. Then, press the number button for the ones digit. Playback starts after the track number is input.

Example: entering track number 7

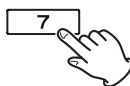

Example: entering track number 23

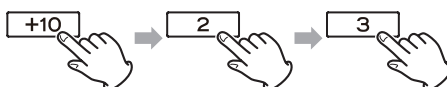

- During program or shuffle playback, the number buttons cannot be used to select tracks.

Listening to CDs (continued)

Selecting tracks on MP3/WAV discs

Navigation mode

You can select files and folders using the folder hierarchy.

1 When stopped, press the stop (■) button.

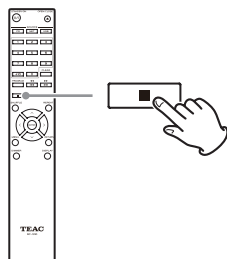

"Root" appears on the display and navigation mode is activated.

NOTE

When the setting "STOP KEY" on page 44 is set to "Navigation", pressing the main unit stop (■) button activates navigation mode.

2 Press the play (▶) button.

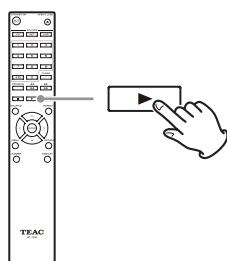

The name of the first folder inside the Root directory appears.
If there are no folders, the name of the first file appears.

3 Use the skip (⏮/⏭) buttons to select folders and files on the same level.

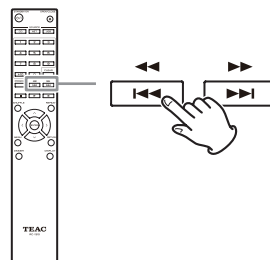

To select files and subfolders inside another folder, after selecting that folder, press the play (▶) button.

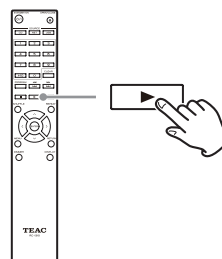

Use the skip (⏮/⏭) buttons to select subfolders and files inside that folder.

- To move up one level, press the pause (⏸) button.

4 After selecting the desired file, press the ENTER button or play (▶) button.

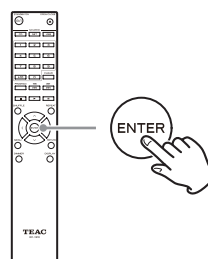

This starts playback of that file.

All folder mode

You can also select folders and files in this mode, but all folders are treated equally regardless of position in the folder structure.

1 When stopped, press the pause (II) button.

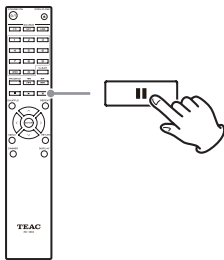

"1" appears on the display and all folder mode is activated.

NOTE

When the setting "STOP KEY" on page 44 is set to "All Folder", pressing the main unit stop (■) button activates all folder mode.

2 Use the skip (I<</>>I) buttons to select a folder, and press the ENTER button or play (▶) button to enter that folder.

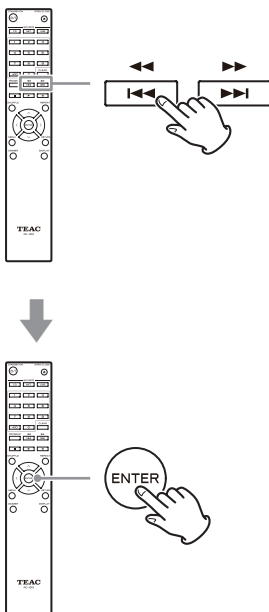

3 Use the skip (I<</>>I) buttons to select a file.

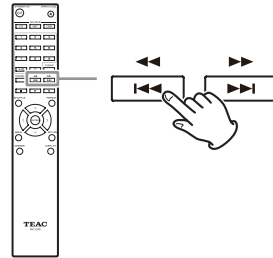

4 After selecting the desired file, press the ENTER button or play (▶) button.

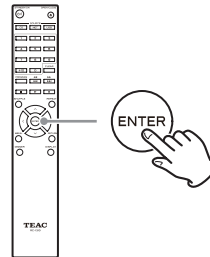

This starts playback of that file.

Listening to CDs (continued)

Program playback

Program playback can be used with audio CDs and MP3/WAV discs.

This unit can have up to 25 tracks in the program.

- Add tracks to the program when the unit is stopped.

1 Press the PROGRAM button.

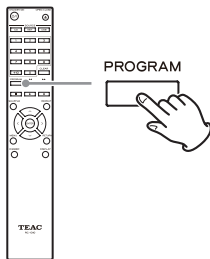

Example: Audio CD loaded

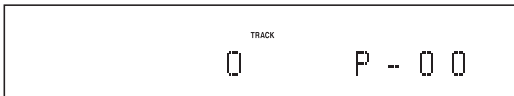

Example: MP3/WAV disc loaded

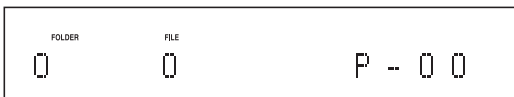

2 Add tracks to the program.

Programming with an audio CD

Use the skip (◀◀/▶▶) buttons to select a track to program.

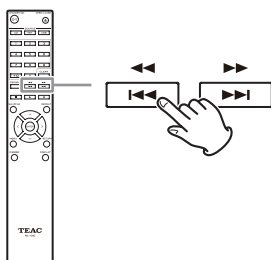

Example

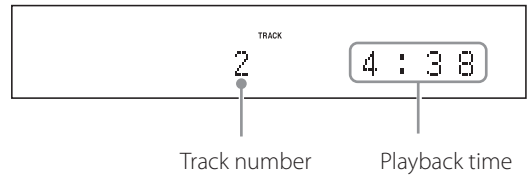

When using an audio CD, you can also select tracks using the number buttons ("Direct playback using track numbers" on page 25).

Press the play (▶) button to add the track to the program.

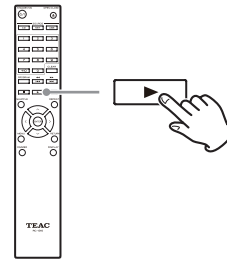

Example

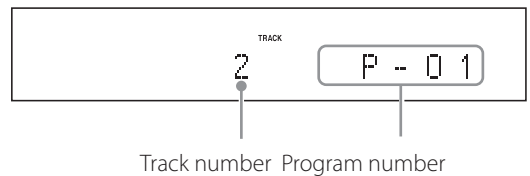

Repeat these procedures to add other tracks as needed.

Programming with an MP3/WAV disc

Follow the procedures in "Selecting tracks on MP3/WAV discs" on page 26 to add tracks.

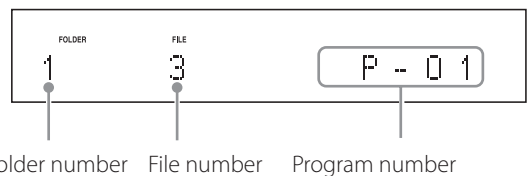

3 Press the play (▶) button to start playback.

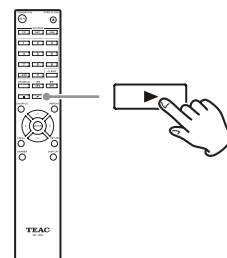

Skipping to search for a track

Press the skip (I◀◀/▶▶I) buttons to play tracks from earlier or later in the program. Keep pressing until the desired track is selected.

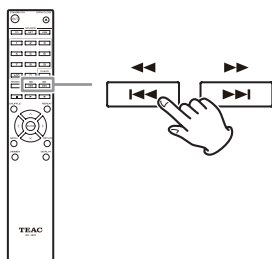

- During playback, press the I◀◀ button once to return to the beginning of the current track. To return to the beginning of an earlier track, keep pressing the I◀◀ button.

Checking the program content

When stopped, use the skip (I◀◀/▶▶I) buttons to show track numbers and playback times.

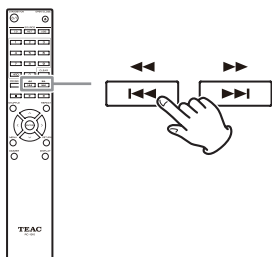

Clearing tracks from the program

When stopped, press the CLEAR button to remove the last track that was added to the program.

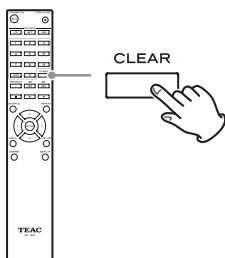

Adding tracks to the end of the program

When stopped, use the skip (I◀◀/▶▶I) buttons to show the track that you want to add and press the play (▶) button to add it to the end of the program.

Ending program playback

Press the stop (■) button to stop playback, and then press the PROGRAM button.

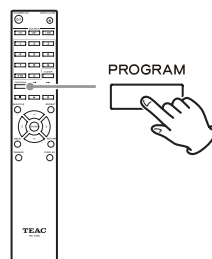

- Program playback will also end if you press the tray open/close (▲) button to open the tray or press the STANDBY/ON button to put the unit into standby.

Listening to files on a USB flash drive

When playing audio files from a USB flash drive, unless using repeat playback set to Repeat All, only the audio files in the same level of a single folder will be played back (page 32).

For details about audio files that can be played back, see “Audio files playable by this unit” on page 12.

1 Press the SOURCE button to change the source to USB(F) or USB(R).

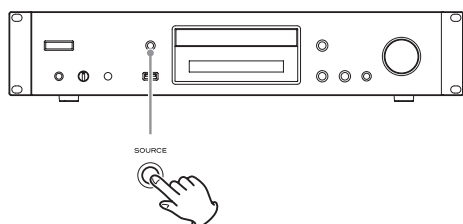

When using the remote control, press the USB button.

- “Not Connected” will appear when nothing is connected.

2 Connect a USB flash drive to the selected USB port.

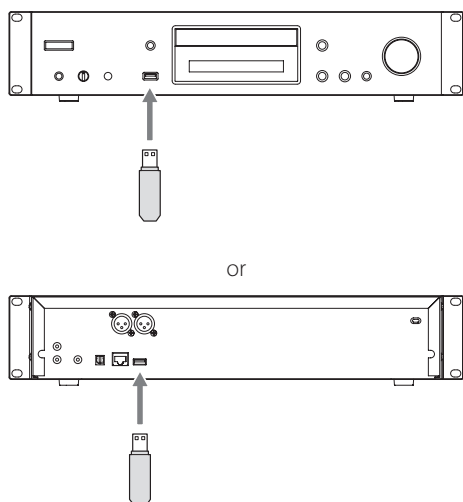

When a USB flash drive is detected, its volume label will be displayed.

- In this state, you can press the play/pause (▶/||) button to start playing the tracks in the first folder that contains audio files on the USB flash drive. The tracks will play back in order.

3 Press the MENU/ENTER (◀◀/▶▶) dial.

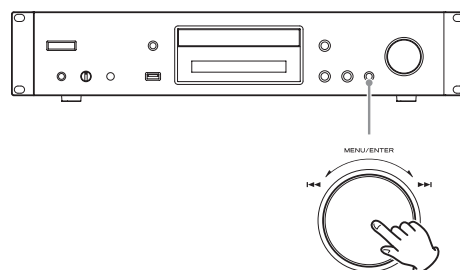

The name of the track or folder appears.

- Using the remote control, you can also press the ENTER button.

4 Turn the MENU/ENTER (◀◀/▶▶) dial to select a track and press the play/pause (▶/||) button.

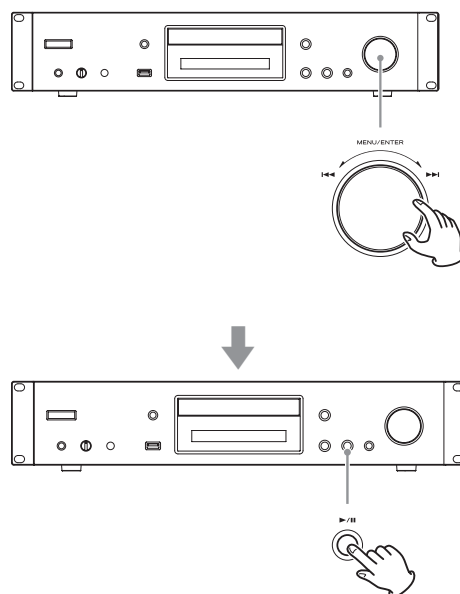

This starts playback of the selected track.

Shuffle playback (CD/USB)

- Using the remote control, you can select tracks with the direction (▲/▼) buttons and then press the play (▶) button.
- When a folder is selected, the first track in that folder will start playing back.
- You can also select a folder and then press the MENU/ENTER (◀◀/▶▶) dial to select tracks inside that folder.
- See "Audio files playable by this unit" on page 12 for the audio formats that can be played.

Use this function to play back tracks in random order. Press the SHUFFLE button to turn shuffle playback on/off.

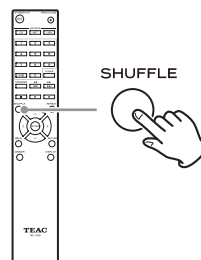

When using an audio CD or MP3/WAV disc

You can shuffle playback to reorder the tracks randomly and play them all once. This mode can only be activated when the unit is stopped.

Press the SHUFFLE button to activate shuffle playback mode. When activated, the  icon will appear on the left side of the display.

- If you press the SHUFFLE button during playback, the current playback mode (either "Normal Play" or "Shuffle Play") will appear, but the playback mode cannot be changed.

Shuffle playback will be canceled in the following cases.

- When the unit is put into standby
- If the disc tray is opened

When using a USB flash drive

The audio files within a folder will be played back repeatedly in random order.

If you press the SHUFFLE button to activate shuffle playback mode, the  icon will appear on the left side of the display.

Shuffle playback will be canceled in the following cases.

- When Net Standby is set to Disable and the power is in standby mode (page 45)
- When repeat playback is used (page 32)

Repeat playback (CD/USB)

Press the REPEAT button to cycle through repeat modes as follows.

When using an audio CD or MP3/WAV disc

Each time you press the REPEAT button, the icon shown on the left side of the display will change as follows.

- Repeat playback can be used in combination with shuffle playback of the files on a disc.

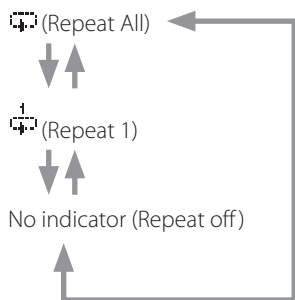

Repeat playback will be canceled in the following cases.

- When the unit is put into standby
- If the disc tray is opened

When using a USB flash drive

Each time you press the REPEAT button, the icon shown on the left side of the display will change as follows.

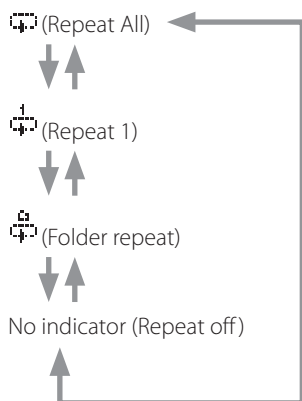

- Repeat playback will be canceled when shuffle playback is used (page 31).
(when shuffle playback mode ends, the set repeat playback mode will become active again)

Listening to an iPod/iPhone

The Apple products that can be connected to and used with this unit are listed in "Using an iPod or iPhone" on page 8.

The following explanations refer to an iPod, but they also apply to use with an iPhone.

1 Press the SOURCE button to change the source to USB(F).

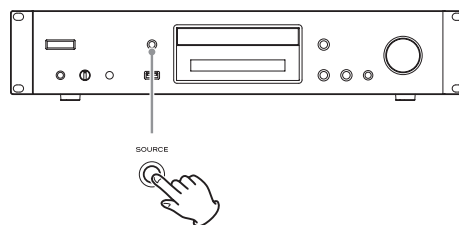

When using the remote control, press the USB button.

- "Not Connected" will appear when no iPod is connected.

2 Connect an iPod to this unit using the USB cable supplied with the iPod.

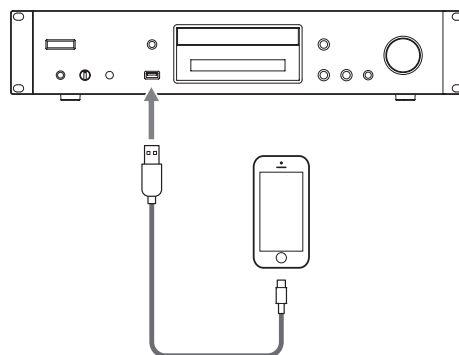

- Connect an iPod to the iPod/iPhone USB connector on the front of the unit.

3 Operate the iPod to start playback.

- "USB(iPod)" appears on the display. No information about the content is shown.
- If an iPod is connected to this unit, it will only be recharged when this unit is ON. Recharging will stop when the iPod is fully recharged. Recharging is not possible when this unit is in standby.

Using network services

To use a network service, follow the procedure below to select it.

- 1 Press the NET button to open the network service menu.**

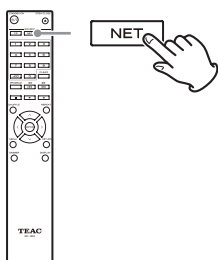

- 2 Use the direction (^/~/</>) buttons to select the item and press the ENTER button.**

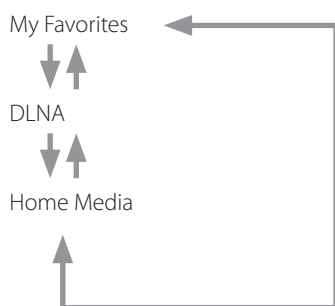

See the following explanations for how to use each item.

My Favorites

To listen to Internet radio programs, you can add them to the "My Favorites" item in the network service menu.

DLNA (media sharing)

This allows you to play audio files in a shared library.

Home Media (folder sharing)

This allows you to play audio files that are in a shared folder on a computer or network attached storage (NAS) device on the same network as this unit.

- Use a computer that has Windows 8 or Windows 7 and Windows Media Player 11 or later installed.
- An Internet connection is necessary to listen to Internet radio (page 44).

My Favorites

This unit supports Internet radio stations that use the PLS, M3U and podcast (RSS) formats. Even if an Internet radio station uses one of these formats, playback might not always be possible depending on the type of data and playback format.

To listen to Internet radio programs, follow these procedures to add them to the “My Favorites” item in the network service menu.

- An Internet connection is necessary to listen to Internet radio programs (page 44).
- A computer must be connected to the same network as this unit in order to make My Favorites settings.

CAUTION

If service from the service provider stops, use of that network services and contents might cease to be possible.

Adding a program

1 Press the MENU button.

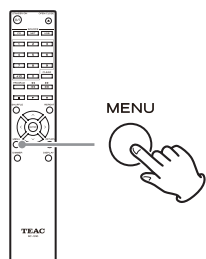

2 Use the direction(^/∨) buttons to select “NET Setting” and press the ENTER button.

3 When “IP Address” appears press the ENTER button.

Make a note of the IP address.

4 Turn the computer on and open Internet Explorer or another Internet browser.

5 Input this unit's IP address into the Internet browser URL field.

This unit's WEB Setup information screen will open in the Internet browser.



- When using Internet Explorer, you can also do this by selecting “Open...” from the “File” menu and inputting the IP address.

6 Click the “My Favorites” tab and input the name and URL of the Internet radio station.

- You can input a maximum of 10 characters for the name of Internet radio stations.

7 Click “Save” to finish registering that Internet radio station.

The registered Internet radio station will be added to “My Favorites”.

When using Internet radio stations, commercial use permission must be obtained from radio stations that allow it.

Starting playback

- 1 Press the NET button.**
- 2 Select “My Favorites” from the network service menu and press the ENTER button to show the Internet radio stations.**
- 3 Select the one that you added and press the ENTER button.**

NOTE

- To see similar stations, press and hold the remote control MENU button, use the direction (∧/∨) buttons to select “Stations like this” and press the ENTER button.
- If you want to add a new radio station to the My Favorites menu, select the blank item in the list and press and hold the MENU button and use the ENTER button to select “Create new station”. Press the ENTER button again to show fields where characters can be input and input the name and URL.
- To remove a radio station that has been added, press and hold the MENU button while that station is playing or select it and use the direction (∧/∨) buttons to select “Delete from My Favorites” and press the ENTER button. You can also remove stations using the WEB Setup screen (on a computer).
- To change the name of a radio station that has been added, select the radio station and press and hold the MENU button. Then, use the direction (∧/∨) buttons to select “Rename this station” and press the ENTER button.
- You can register up to 40 Internet radio stations.

DLNA

When using DLNA, the unit can play audio files in shared libraries and show their tag information, including artist names, genres and album names.

- A computer must be connected to the same network as this unit in order to use DLNA.
- See "Note about servers" on page 13 for information about supported network servers.
- Set the network server so that this unit can access it in advance. For information about these settings, see the operation manual of the network server. If using Windows Media Player, see "Setting up Windows Media Player" on page 39.

1 Start the computer or network server.

2 Press the NET button to open the network service menu.

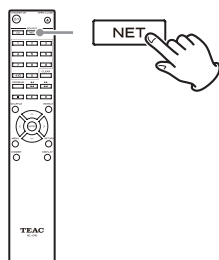

3 Use the direction (^/~/</>) buttons to select "DLNA" and press the ENTER button.

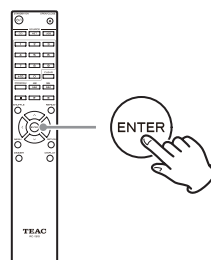
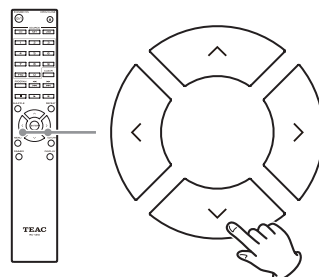

4 Use the direction (^/~/</>) buttons to select the network server and press the ENTER button.

The network server folder will be shown.

- Some network servers do not support use of the search function.
- This unit cannot access photographs or videos on a network server.
- Depending on network server sharing settings, some contents might not be shown. See the operation manual of the network server.

5 Use the direction (^ / \) buttons to select the audio file that you want to play, and press the ENTER button or play (►) button.

- Searching forward/backward and pausing functions might not work with some media servers.
- If information cannot be retrieved from a server, “No Item” will appear on the display. If this occurs, check the server and network connections.
- Immediately after an audio file is added to a Windows Media Player library, that file might not appear in this unit's audio file list. This is because the Windows library index has not been refreshed. You can either wait for the index to refresh automatically, or you can manually rebuild the index. See Windows online help for instructions about how to do this.

Using the Play To feature

The Play To function allows you to operate DLNA-compliant controller devices and computers on a home network and enables this unit to play audio files that are saved on those devices.

- A DLNA-compliant controller device or computer and this unit must be connected to the same network in order to make My Favorites settings.

1 Turn this unit on.

2 Turn the computer on, and open Windows Media Player.

You must set Windows Media Player in advance (page 39).

3 Select the file that you want to play in Windows Media Player and right-click it.

This opens a pop-up menu.

NOTE

To use the Play To feature with audio files on a different network server, open that network server from the list that appears under “Other Libraries” and select the audio file that you want to play.

4 Click the “Play To” button and select this unit from the Play To list.

Open the Windows Media Player Play To dialog box, and start playback from this unit.

Use the Play To dialog box in Windows 7 to control remote playback.

- The Play To feature cannot be used under the following conditions.
 - When using network services
 - During playback of an audio file on a USB device or an iPod/iPhone

Home Media

This unit can play audio files that are in a shared folder on a computer or network attached storage (NAS) device on the same network.

Referring to “Making shared folder settings” on page 40, create a shared folder that this unit can access.

CAUTION

When using network attached storage (NAS), check its operation manual.

- 1 Press the NET button to open the network service menu.**

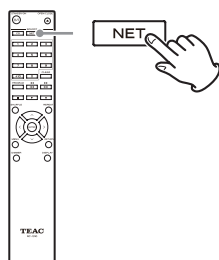

- 2 Use the direction (↑/↓/←/→) buttons to select “Home Media” and press the ENTER button.**

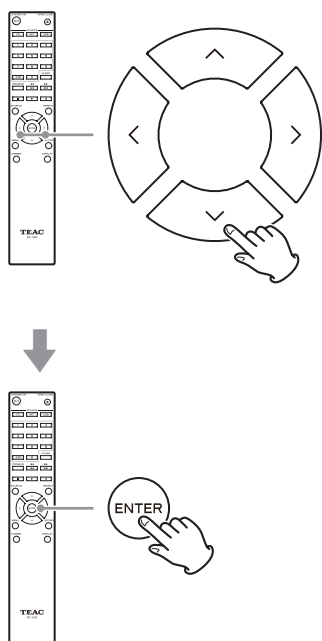

- 3 Use the direction (↑/↓) buttons to select the server that you want to use and press the ENTER button.**

- Confirm the server name of your computer by viewing its properties.

- 4 Use the direction (↑/↓) buttons to select the shared folder that you want to use and press the ENTER button.**

- 5 When a user name and password are required, input the necessary account information.**

- After inputting the account information once, it is saved, so you will not need to input it the next time.
- Use the account information set when you created the shared folder.

- 6 Use the direction (↑/↓) buttons to select the audio file that you want to play, and press the ENTER button or play (▶) button.**

Playback will start.

Setting up Windows Media Player

As an example, we explain how to set Windows Media Player 12 in this section.

1 Connect your computer to a network.

2 Connect this unit to the network.

If you have a problem connecting to the network, see the "DLNA" section of "Troubleshooting".

- If the files you want to share are not yet in the library of Windows Media Player, add them to the library.
Refer to the manual of Windows Media Player for details.

3 From the "Stream" menu of Windows Media Player, select "Automatically allow devices to play my media..."

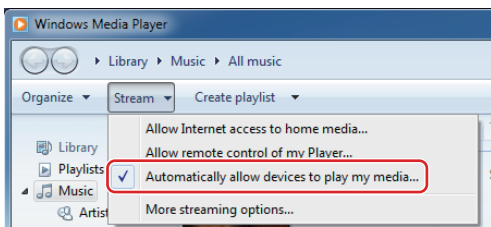

- If "Automatically allow devices to play my media..." or "More streaming options..." does not appear, select "Turn on media streaming..."

4 From the "Stream" menu of Windows Media Player, select "More streaming options..."

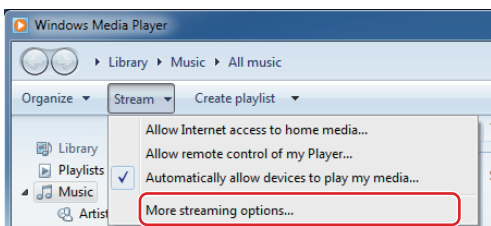

- If "More streaming options..." does not appear, select "Turn on media streaming..."

5 Select this unit from the device list, then click "Customize..."

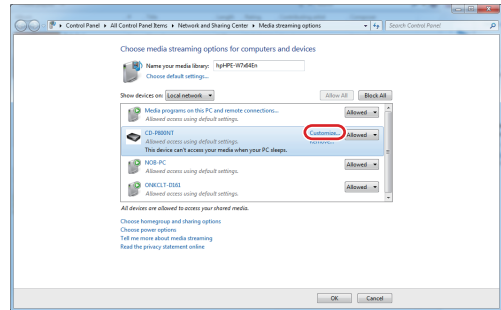

6 Make sharing settings, and click "OK".

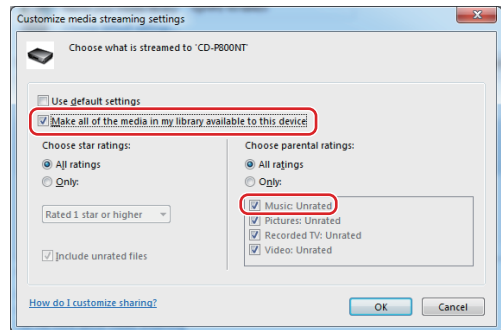

- To play files regardless of their ratings, set "Choose star ratings" to "All ratings".
- Ensure that "Music" is checked.

7 Click "OK" on the screen that appears.

For playback instructions, see "DLNA" on page 36.

Making shared folder settings

Windows 8

1 Check the name of the domain or workgroup to which your computer is assigned.

Before setting folder sharing, confirm that the computer is assigned to the same domain or workgroup as this unit. (By default, this unit is assigned to the same workgroup.) Open “Control Panel”, “System and Security”, and then “System” to check this setting.

2 Check the user account name and its password.

To access the computer from this unit, you need the user account name and the password of the computer.

3 Open “Control Panel”, “Network and Internet”, and then “Network and Sharing Center”.

4 Click “Change advanced sharing settings”.

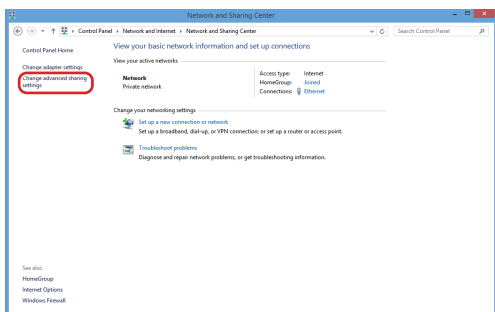

5 For “Public folder sharing”, select “Turn on sharing so anyone with network access can read and write files in the Public folders”.

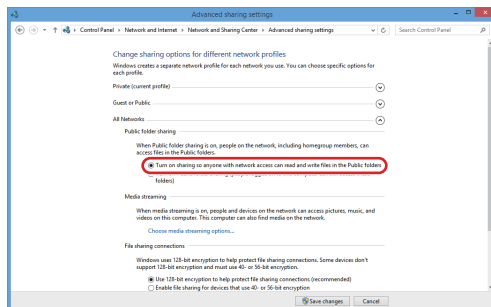

6 Copy the music files you want to play back with this unit into the “Public Music” sub-folder of the “Public” folder.

Windows 7

1 Check the name of the domain or workgroup to which your computer is assigned.

Before setting folder sharing, confirm that the computer is assigned to the same domain or workgroup as this unit. (By default, this unit is assigned to the same workgroup.) Open “Control Panel”, “System and Security”, and then “System” to check this setting.

2 Check the user account name and its password.

To access the computer from this unit, you need the user account name and the password of the computer.

3 Open “Control Panel”, and then “Network and Sharing Center”.

- If “View by” is set to “Category” in the Control Panel, open “Network and Internet”, and then “Network and Sharing Center”.

4 Click “Change advanced sharing settings”.

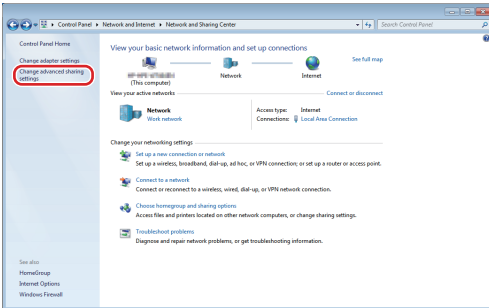

5 For “Public folder sharing”, select “Turn on sharing so anyone with network access can read and write files in the Public folders”.

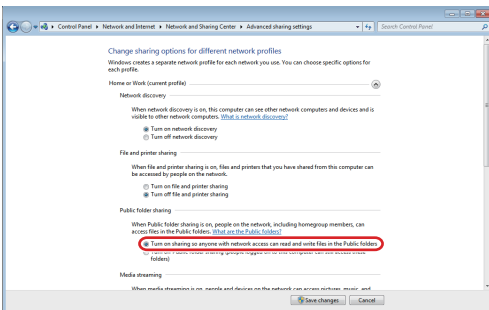

6 Click “Save changes”.

7 Copy the music files you want to play back with this unit into the “Public Music” sub-folder of the “Public” folder.

Settings

Follow the procedures below to open the menu and change settings.

1 Press the MENU button.

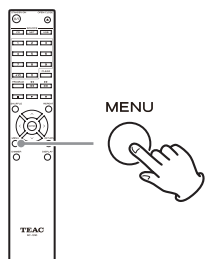

- You can also press and hold the MENU/ENTER (◀◀/▶▶) dial on the main unit to do this.

2 Use the direction (∧/∨) buttons to select the setting you want to change.

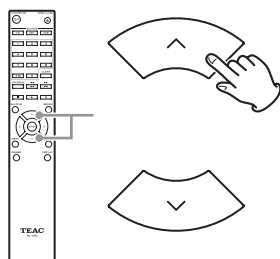

Press a direction (∧/∨) button repeatedly to cycle through the settings in the following order.

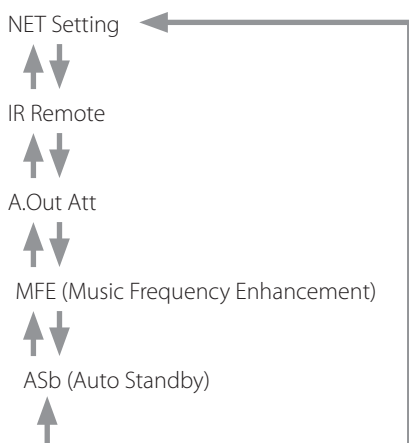

- “MFE” only appears when the source is set to USB/NET.
- “MP3 setting” only appears when the source is set to CD.
- The setting shown first depends on the current

source.

You can also turn the MENU/ENTER (◀◀/▶▶) dial on the main unit to do this.

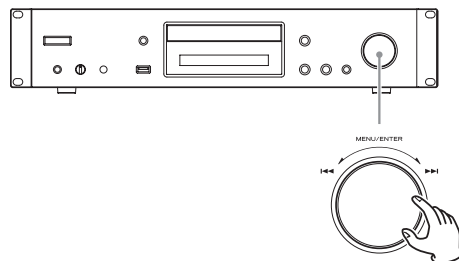

3 Press the ENTER button.

You can also press the MENU/ENTER (◀◀/▶▶) dial on the main unit to do this.

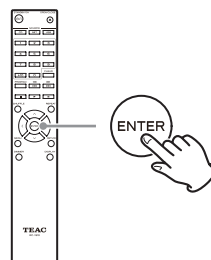

After opening “MP3 setting” or “NET Setting”, repeat steps **2** and **1** to make a selection in the submenu.

- You must wait at least one minute after turning the unit on to select and change the “NET Setting” and “Update” items.

4 Use the direction (</>) buttons to change setting values.

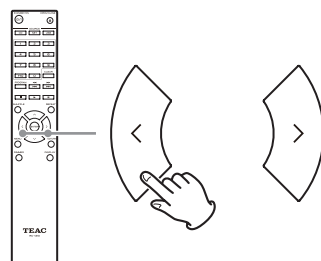

変更済

- You can also turn the MENU/ENTER (◀◀/▶▶) dial on the main unit to do this.

- 5** Press the **ENTER** button to confirm the change.

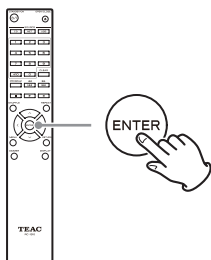

- You can also press the MENU/ENTER (◀◀/▶▶) dial on the main unit to do this.

- 6** After you complete making settings, press the **RETURN** button to close the menu screen.

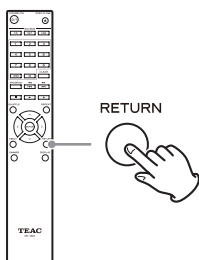

CAUTION

When you press the RETURN button while viewing the "NET Setting" submenu, "Network Save?" will appear. Press the ENTER button to save the settings. If you press the RETURN button, the menu screen will close without saving the setting changes.

MP3 Setting

You can set how MP3/WAV file information is shown and how MP3/WAV discs are played back, for example. These settings can only be changed when the disc is stopped.

BAD NAME

Set how MP3/WAV file information is shown.

- Regardless of the setting, characters that cannot be shown in ID3 tag information are replaced with asterisks (*).

Replace

If a track or folder name contains a character that cannot be shown, "File_n" or "Folder_n" (with "n" being the track/folder number) will be shown instead.

Not (default setting)

Characters that can be shown are shown and characters that cannot be shown are replaced with asterisks (*).

ID3 VER.1

Set how ID3 Version 1.0/1.1 tag information is shown.

Read (default setting)

The unit will load tag information and show it.

Not Read

Tag information will not be shown.

ID3 VER.2

Set how ID3 Version 2.2/2.3/2.4 tag information is shown.

Read (default setting)

The unit will load tag information and show it.

Not Read

Tag information will not be shown.

Settings (continued)

HIDE NUMBER

The unit can hide numbers that are attached to the beginnings of track and folder names.

Disable (default setting)

Such numbers will be shown.

Enable

Such numbers will not be shown.

NOTE

When an MP3/WAV CD is made on a computer, the ordinary file playback order is not determined. By adding numbers like 01, 02 and 03 to the beginnings of MP3/WAV file names, however, they can be played back in numerical order.

STOP KEY

You can set the function of the stop (■) button on the main unit.

Navigation (default setting)

Pressing the stop (■) button activates navigation mode.

All Folder

Pressing the stop (■) button activates "all folder" mode.

Disable

Pressing the stop (■) button does not activate navigation or all folder mode.

MFE (Music Frequency Enhancement)

MP3s and other files that use irreversible compression formats have reduced audio quality compared to the original sound sources due to their compression.

Use MFE to optimize compressed audio.

Disable (default setting)

MFE is not used.

Enable

MFE is used.

ASb (Auto Standby)

When the Auto Standby function is on, the unit will automatically enter standby mode if 20 minutes pass under the conditions described below.

Playback source	Condition
CD	No disc loaded or disc stopped
NET USB	Input source not playing

When this function is enabled, "ASb" appears on the display. Use the "Net Standby" setting to set how network control affects standby (page 45).

Off (default setting for US/Canadian model)

Auto Standby is disabled.

On (default setting for European model)

Auto Standby is enabled.

NET Setting

To use network services, make network settings on this unit in advance.

Make the settings according to the characteristics of the network to which it is being connected.

- An Internet connection is necessary to listen to Internet radio.
- The "Net Standby" setting is not necessary for connecting this unit to a network.

CAUTION

- If DHCP is set to Enable (default), "IP Address", "Subnet Mask", "Gateway" and "DNS Server" settings will appear, but cannot be changed. If DHCP is set to Disable, "IP Address", "Subnet Mask", "Gateway" and "DNS Server" will appear and must be set.
- When you press the RETURN button when viewing the "NET Setting" submenu, "Network Save?" will appear. After changing a setting, press the ENTER button to save it. If you press the RETURN button, the menu screen will close without applying the setting changes.
- To set the IP Address, Subnet Mask, Gateway and DNS Server, you must use Internet Explorer or another web browser on a computer connected to the same network as this unit to open the Web Setup screen. Click its Network Setting tab to open the Network Setting screen where you can set these items. See page 34 for information about opening the Web Setup screen.

Inputting characters

Follow these procedures to input characters when using the NET Setting and My Favorites menus, for example.

1 Use the remote control direction (^ / \ / < / >) buttons to select a character or symbol and press the ENTER button.

Repeat this procedure to input more characters.

- A maximum of 10 characters can be input for the name of Internet radio stations in "My Favorites".

2 After completing input, use the remote control direction (^ / \ / < / >) buttons to select "OK" and press the ENTER button.

If this is not done, the input characters will not be saved.

The following characters can be used.

a	b	c	d	e	f	g	h	i	j	k	l	m
n	o	p	q	r	s	t	u	v	w	x	y	z
1	2	3	4	5	6	7	8	9	0	-	^	\
,	.	/	;	:	@	[]	Space				
Shift				←	→	BS		OK				

A	B	C	D	E	F	G	H	I	J	K	L	M
N	O	P	Q	R	S	T	U	V	W	X	Y	Z
!	"	#	\$	%	&	`	()	_	=	~	
<	>	?	+	*	'	{	}	Space				
Shift				←	→	BS		OK				

Space

This inputs a blank space that is one-character wide.

Shift*

This changes the characters shown.

← (left)/→ (right)

Use these to move the cursor in the text input area.

BS (backspace)**

Delete characters to the left of the cursor. Move the cursor left.

OK

Select when input complete.

*You can also change them by pressing the +10 button.

**You can press the CLEAR button to delete all the input characters at once.

The submenus appear in the following order.

IP Address

View/set the IP address.

MAC Address

View this unit's MAC address.

DHCP

Enable (default setting)

DHCP is enabled.

Disable

DHCP is disabled.

Subnet Mask

View/set the subnet mask.

Gateway

View/set the default gateway.

DNS Server

View/set the DNS server address.

Proxy URL

Set the proxy server address.

Proxy Port

Set the proxy port number.

- This only appears when a proxy URL has been set.

Net Standby

This sets whether or not the unit can be controlled over a network when the unit is in standby.

Disable (default setting)

When the unit is in standby, it cannot be controlled over a network.

Enable

When the unit is in standby, it can be controlled over a network.

- When set to "Enable", more power will be consumed when the unit is in standby.

Update

Version

This shows the current firmware version.

Troubleshooting

If you experience a problem with this unit, please check the following items before requesting service.

If it still does not operate correctly, contact the retailer where you purchased the unit.

General

The unit does not turn on.

- ➔ Confirm that the power plug is securely plugged in to an outlet.
- ➔ Unplug the power cord once, wait five seconds and then plug it in again.

The unit turns off.

- ➔ When the Auto Standby function is enabled, the unit will enter standby automatically after a set amount of time. Check the settings (page 44).

No sound is output.

- ➔ Confirm that the input source is selected correctly.

No sound is output from the headphones.

- ➔ This could be caused by contact failure. Clean the headphones plug. (See the headphones operation manual for instructions about how to clean the plug.) Another possibility is that the wire in the headphones cable has broken, so check the cable.

Remote control does not work.

- ➔ If the batteries are exhausted, replace both of them with new ones.
- ➔ Point the remote control at the front panel of the unit from a distance of less than about 5 m (16 ft) (page 17).
- ➔ The remote control will not work if there is an obstruction between it and the main unit. In this case, try changing the position.
- ➔ If a fluorescent light is near the unit, turn the light off.

There is noise.

- ➔ Place the unit as far away as possible from TVs and other devices that have strong magnetism.

CD player

Playback is not possible.

- ➔ If the disc is upside down, reload it with the labeled side up.
- ➔ If the disc is dirty, wipe it clean.

- ➔ If a blank disc is loaded, replace it with a disc that has recordings on it.
- ➔ Depending on the quality of the disc and the condition of the recording, playback of a CD-R/CD-RW might not be possible.
- ➔ This unit cannot play back unfinalized CD-R/CD-RW discs.

The sound skips.

- ➔ Vibrations will cause the sound to skip. Install this unit in a stable location.
- ➔ If the disc is dirty, wipe it clean.
- ➔ Do not use discs that are scratched or cracked.

Audio files

Playback is not possible.

- ➔ Check the file format. For information about playable file types, see "MP3/WAV formats" on page 11 for CDs and "Audio files playable by this unit" on page 12 for USB and playback over a network.

The names of tracks, artists and albums are not shown.

- ➔ There is no ID3 tag information for the music file. Use a computer, for example, to prepare MP3 files with corrected ID3 tag information.

Some characters are not shown correctly.

- ➔ This unit cannot display symbols and full-size or double-byte characters (such as Japanese, Chinese, etc.) correctly. File names for MP3, WMA or other file formats should consist of alphanumeric characters. If the file information uses Japanese, Chinese or other double-byte characters, playback is possible but the name will not be shown correctly.

iPod/iPhone

Playback is not possible.

- ➔ Disconnect the iPod/iPhone from the USB port, wait a few seconds, and connect it again.
- ➔ Updating to the latest iPod/iPhone software might resolve the problem.
Download the latest software from the following website.
<http://www.apple.com/support/country/?dest=downloads>

Cannot operate the iPod/iPhone.

- ➔ Make sure the iPod/iPhone is not locked.

- ➔ You cannot adjust the unit volume using an iPod/iPhone.

Internet radio

Cannot connect to the Internet.

- ➔ Confirm that a computer can connect to the Internet using the same network.
- ➔ Enter a correct network connection password.
- ➔ Check the settings of the network's firewall.
- ➔ The station/podcast might not be available at the moment.
- ➔ The link for the station/podcast might be out of date.
- ➔ The number of registered users for the station/podcast might have already reached a limit, making it unavailable to the public.
- ➔ If the Internet connection speed is too slow, searching might take time.

Cannot listen to an Internet radio station or podcast.

- ➔ The broadcaster might have a temporary problem with their Internet connection.
- ➔ Confirm that your system is properly connected to the Internet.

DLNA

Cannot connect to the network.

- ➔ Check the settings of the network's firewall.
- ➔ Confirm that a DLNA server on the same network can connect to the network.
- ➔ Confirm that the password to connect to the DLNA server is correct.
- ➔ Confirm that the DLNA server is not shut down or in sleep mode.
- ➔ There might be a problem with the network authentication. Press the SOURCE button to select NET again.

Cannot find a track.

- ➔ Add the track to the media library of Windows Media Player.
- ➔ Select this unit from the Windows device list.
- ➔ If the computer is using antivirus or security software, the unit might not be able to connect to it.

Home Media

Cannot find a folder/file.

- ➔ Make folder/file sharing settings.
- ➔ Add the file to the shared folder.

- ➔ Confirm that the password for the user account is correct.
- ➔ Check the file format.
- ➔ If the computer is using antivirus or security software, the unit might not be able to connect to it.

This unit uses a microprocessor, so noise and other external interference could cause it to stop functioning properly. If this should occur, unplug the unit's power from the outlet and wait a little while before plugging the power in again and retrying the operation.

If the unit still does not function properly after doing the above, follow the procedures in "Restoring factory default settings" on page 47 to restore the unit to its factory default settings and try the operation again.

Restoring factory default settings

If this unit does not operate properly, follow the procedures below to restore it to the default settings that it had when shipped new from the factory. Doing this might correct the problem.

While the unit is on, press and hold the stop (■) button and press the STANDBY/ON button.

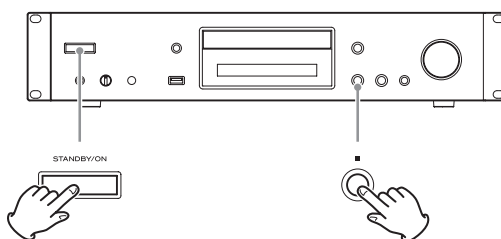

Note about condensation

If this unit is brought from a cold outdoor environment into a warm room, or the heater has just been turned on in the room where it is located, for example, condensation might occur on operating parts or lenses, resulting in improper operation. If this occurs, leave the unit on and wait 1-2 hours. This should enable normal playback.

Specifications

Audio formats

CD

CD-DA

Sampling frequency44.1 kHz
Quantization bit rate 16-bit

CD-DATA

MP3

Sampling frequency...16 kHz, 22.05 kHz, 24 kHz, 32 kHz,
44.1 kHz, 48 kHz
Bit rate 8 kbps–320 kbps or VBR

WAV

Sampling frequency...8 kHz, 11.025 kHz, 12 kHz, 16 kHz,
22.05 kHz, 24 kHz, 32 kHz, 44.1 kHz, 48 kHz
Quantization bit rate8-bit, 16-bit

NET and USB

PCM

MP3

Sampling frequency...8 kHz, 11.025 kHz, 12 kHz, 16 kHz,
22.05 kHz, 24 kHz, 32 kHz, 44.1 kHz, 48 kHz
Bit rate 8 kbps–320 kbps or VBR

WMA

Sampling frequency..... 8 kHz, 11.025 kHz, 16 kHz,
22.05 kHz, 32 kHz, 44.1 kHz, 48 kHz
Bit rate 5 kbps–320 kbps or VBR

WMA Lossless

Sampling frequency...44.1 kHz, 48 kHz, 88.2 kHz, 96 kHz
Quantization bit rate 16-bit, 24-bit

WAV

Sampling frequency...8 kHz, 11.025 kHz, 12 kHz, 16 kHz,
22.05 kHz, 24 kHz, 32 kHz, 44.1 kHz, 48 kHz,
64 kHz, 88.2 kHz, 96 kHz, 176.4 kHz, 192 kHz
Quantization bit rate8-bit, 16-bit, 24-bit

AAC

Sampling frequency...8 kHz, 11.025 kHz, 12 kHz, 16 kHz,
22.05 kHz, 24 kHz, 32 kHz, 44.1 kHz,
48 kHz, 64 kHz, 88.2 kHz, 96 kHz
Bit rate 8 kbps–320 kbps or VBR

FLAC

Sampling frequency..... 8 kHz, 11.025 kHz, 16 kHz,
22.05 kHz, 32 kHz, 44.1 kHz, 48 kHz,
64 kHz, 88.2 kHz, 96 kHz, 176.4 kHz, 192 kHz
Quantization bit rate8-bit, 16-bit, 24-bit

Ogg Vorbis

Sampling frequency..... 8 kHz, 11.025 kHz, 16 kHz,
22.05 kHz, 32 kHz, 44.1 kHz, 48 kHz
Bit rate48 kbps–500 kbps or VBR

Apple Lossless

Sampling frequency...8 kHz, 11.025 kHz, 12 kHz, 16 kHz,
22.05 kHz, 24 kHz, 32 kHz, 44.1 kHz,
48 kHz, 64 kHz, 88.2 kHz, 96 kHz
Quantization bit rate 16-bit, 24-bit

DSD

Sampling frequency..... 2.8224 MHz, 5.6448 MHz

Input/output connectors

LAN100BASE-T

USBFront: USB 2.0 For iPod/iPhone
(+5V/1A power supply)
Rear: USB1.1 (Type A)
(+5V/500mA power supply)

DIGITAL OUTPUT

COAXIAL

Connector..... RCA Pin Jack
Compatible Signal Format...Compliant with IEC-60958-3
standard for consumer applications (S/PDIF)

OPTICAL

Connector.....TOS (JEITA RC-5720C)
Compatible Signal Format...Compliant with IEC-60958-3
standard for consumer applications (S/PDIF)

ANALOG OUTPUT (BALANCED)

ConnectorXLR3-32
Output Impedance 200 Ω
Reference Output Level +4 dBu (1.23 Vrms)
Maximum Output Level.....+20 dBu (7.75 Vrms)*
Output level adjustment range.0 dB to –14 dB (in 1.0dB steps)

ANALOG OUTPUT (UNBALANCED)

ConnectorRCA pin jack
Output Impedance 200 Ω
Reference Output Level..... –10 dBV (0.32 Vrms)
Maximum Output Level.....+6 dBV (2.0 Vrms)
Output level adjustment range.0 dB to –14 dB (in 1.0dB steps)

Audio performance

Frequency response 10 Hz–70 kHz (+0.5 dB, –3 dB)
 Signal-to-noise ratio..... 114 dB
 (1 kHz, 0dB fs, 192kHz fs, A-Weight)
 Dynamic range 114 dB
 (1 kHz, –60dB fs, 192kHz fs, A-Weight)
 THD+N0002% or less (1 kHz, 0dB fs)
 Channel separation (line)..... 110 dB
 (1 kHz, 0dB fs, 192kHz fs)

PHONES jack

Connector 6.3 mm (1/4") Stereo Phone Jack
 Maximum Output Level..... 55 mW + 55 mW
 (THD+N 1% or less, into 32Ω load)
 Signal-to-noise ratio..... 108 dB
 (1 kHz, 0dB fs, 192kHz fs, A-Weight)
 Frequency response 20 Hz–60 kHz (+1 dB, –3 dB)

General

Power supply
 Model for Europe AC 220-240 V (50 Hz, 60 Hz)
 Model for USA/Canada AC 120 V (50 Hz, 60 Hz)
 Power consumption 31 W
 Standby power042 W (in normal standby mode)
 5.6 W (in network standby mode)
 External dimensions (W × H × D) (including protrusions)
 481 × 94.5 × 301 mm (18 7/8" × 3 3/4" × 11 7/8")
 Weight 5.0 kg (11 lb)
 Operating temperature +5°C to +35°C
 Operating humidity 5% to 85% (no condensation)
 Storage temperature –20°C to +55°C

Dimensions

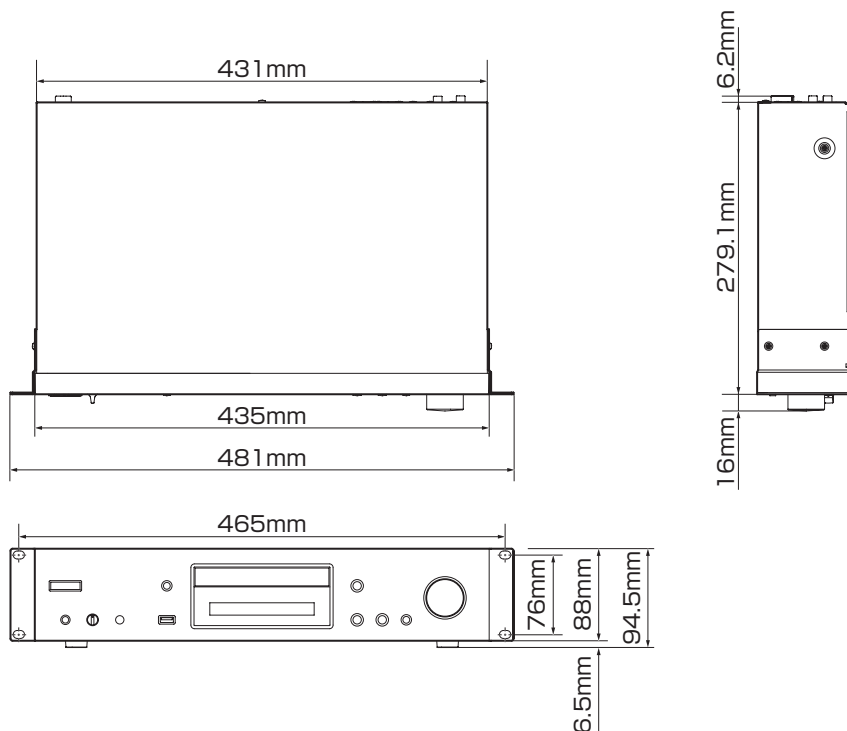

- Specifications and appearance are subject to change without notice.
- Weight and dimensions are approximate.
- Illustrations in this Owner's Manual might differ slightly from production models.

WARRANTY

< In the United States >

This warranty gives you specific legal rights and you may also have other rights which vary from state to state. This warranty is only valid within the country the unit was originally purchased.

WHAT IS AND IS NOT COVERED

Except as specified below, this warranty covers all defects in materials and workmanship in this product. The following are not covered by the warranty:

1. **Damage to or deterioration of the external cabinet.**
2. **Damages resulting from accident, misuse, abuse or neglect.**
3. **Damage resulting from failure to perform basic daily maintenance and/or calibration or otherwise resulting from failure to follow instructions contained in your owner's manual.**
4. **Damage occurring during shipment of the product. (Claims must be presented to the carrier)**
5. **Damage resulting from repair or attempted repair by anyone other than TEAC or an authorized TASCAM service station.**
6. **Damage resulting from causes other than product defects, including lack of technical skill, competence, or experience of the user.**
7. **Damage to any unit which has been altered or on which the serial number has been defaced, modified or is missing.**

WHO MAY ENFORCE THE WARRANTY

This warranty may be enforced only by the original purchaser.

LENGTH OF WARRANTY

All parts except heads and disk drives are warranted for one (1) year from the date of original purchase. Heads and disk drives are warranted to ninety (90) days from date of original purchase. Labor is warranted for ninety (90) days from date of original purchase.

WHAT WE WILL PAY FOR

We will pay all labor and material expenses for items covered by the warranty. Payment of shipping charges is discussed in the next section of this warranty.

HOW YOU CAN GET WARRANTY SERVICE

Your unit must be serviced by an authorized TASCAM service station in the United States. (This warranty is not enforceable outside the U.S.) If you are unable to locate an authorized TASCAM service station in your area, please contact us. We either will refer you to an authorized service station or instruct you to return the unit to the factory. Whenever warranty service is required, you must present a copy of the original dated sales receipt from an Authorized TASCAM Dealer.

You must pay any shipping charges if it is necessary to ship the product to service. However, if the necessary repairs are covered by the warranty, we will pay return surface shipping charges to any destination within the United States.

LIMITATION OF IMPLIED WARRANTIES

Any implied warranties, INCLUDING WARRANTIES OF MERCHANTABILITY AND FITNESS FOR A PARTICULAR PURPOSE, are limited in duration to the length of this warranty.

EXCLUSION OF DAMAGES

TEAC's liability for any defective product is limited to repair or replacement of the product, at TEAC's option. TEAC shall not be liable for:

1. **Damages based upon inconvenience, loss of use of the product, loss of time interrupted operation or commercial loss; or**
2. **Any other damages, whether incidental, consequential or otherwise.**

Some states do not allow limitations on how long an implied warranty lasts and/or do not allow the exclusion or limitation of incidental or consequential damages, so the above limitations and exclusions may not apply to you.

To locate an Authorized Service Center in Your Area

CALL 1-800-447-8322

< Europe >

This product is subject to the legal warranty regulations of the country of purchase. In case of a defect or a problem, please contact the dealer where you bought the product.

Ce produit est sujet aux réglementations concernant la garantie légale dans le pays d'achat. En cas de défaut ou de problème, veuillez contacter le revendeur chez qui vous avez acheté le produit.

Dieses Gerät unterliegt den gesetzlichen Gewährleistungsbestimmungen des Landes, in dem es erworben wurde. Bitte wenden Sie sich im Gewährleistungsfall an den Händler, bei dem sie das Gerät erworben haben.

Questo apparecchio è conforme alle norme sulla garanzia vigenti nel rispettivo Paese in cui esso è stato acquistato. Si prega di rivolgersi al proprio commerciante, presso il quale è stato acquistato l'apparecchio, nel caso in cui si voglia richiedere una prestazione in garanzia.

Las condiciones de garantía de este aparato están sujetas a las disposiciones legales sobre garantía del país en el que ha sido adquirido. En caso de garantía, debe dirigirse al establecimiento donde adquirió el aparato.

< In other countries/areas >

This warranty gives you specific legal rights, and you may also have other rights that vary by country, state or province.

If you have a warranty claim or request, please contact the dealer where you bought the product.

该保证书赋予了顾客特定的合法权利，并且因国家、州或省等地域的不同，顾客可能拥有其他权利。如需申请或要求保修，请与购买本产品的销售店进行联系。

If you require repair services for your TASCAM equipment, please contact the dealer where the product was purchased from or the TASCAM Distributor in your country. A list of TASCAM Distributors can be found on our website at: <http://teac-global.com/>

TASCAM

TEAC CORPORATION

Phone: +81-42-356-9143
1-47 Ochiai, Tama-shi, Tokyo 206-8530 Japan

<http://tascam.jp/>

TEAC AMERICA, INC.

Phone: +1-323-726-0303
1834 Gage Road, Montebello, California 90640 USA

<http://tascam.com/>

TEAC MEXICO, S.A. de C.V.

Phone: +52-55-5010-6000
Río Churubusco 364, Colonia Del Carmen, Delegación Coyoacán, CP 04100, México DF, México

<http://teacmexico.net/>

TEAC UK Ltd.

Phone: +44-8451-302511
2 Huxley Road, Surrey Research Park, Guildford, GU2 7RE, United Kingdom

<http://tascam.eu/>

TEAC EUROPE GmbH

Phone: +49-611-71580
Bahnstrasse 12, 65205 Wiesbaden-Erbenheim, Germany

<http://tascam.eu/>

TEAC SALES & TRADING(SHENZHEN) CO., LTD

Phone: +86-755-88311561~2
Room 817, Block A, Hailrun Complex, 6021 Shennan Blvd., Futian District, Shenzhen 518040, China

<http://tascam.cn/>

Printed in China

WARRANTY

Model/Modèle/Modell
Modello/Modelo/型号

Owner's name/Nom du possesseur/Name des Eigentümers
Nome del proprietario/Nombre del propietario/ 顾客姓名

CD-240
Sample

Serial No./No de Série/Seriennummer
Numero di serie/Número de serie/ 序列号

Address/Adresse/Adresse
Indirizzo/Dirección/ 顾客地址

Date of purchase/Date de l'achat/Datum des Kaufs
Data dell'acquisto/Fecha de compra/ 购买日期

Dealer's name/Nom du détaillant/Name des Händlers
Nome del commerciante/Nombre del establecimiento/ 销售店名

TASCAM

<http://teac-global.com/>

Dealer's address/Adresse du détaillant/Adresse des Händlers
Indirizzo del commerciante/Dirección del establecimiento
销售店地址